

See discussions, stats, and author profiles for this publication at: <https://www.researchgate.net/publication/333245105>

# CLIMATE CHANGE AND SOCIO-ECOLOGICAL TRANSFORMATION IN NIGERIA CHALLENGES AND OPPORTUNITIES

Book · May 2019

CITATIONS  
0

READS  
572

5 authors, including:



**Olawale Olayide**  
University of Ibadan

153 PUBLICATIONS 318 CITATIONS

SEE PROFILE



**Bolanle Wahab**  
University of Ibadan

52 PUBLICATIONS 317 CITATIONS

SEE PROFILE



**Isaac B Oluwatayo**  
University of Venda South Africa

74 PUBLICATIONS 362 CITATIONS

SEE PROFILE



**Funmilola Morakinyo**  
University of Ibadan

1 PUBLICATION 0 CITATIONS

SEE PROFILE

Some of the authors of this publication are also working on these related projects:



PARI & ZEF [View project](#)



Assessing Climate Resilient and Nutritious Cereal Crops in Nigeria [View project](#)

CLIMATE CHANGE AND SOCIO-ECOLOGICAL TRANSFORMATION IN NIGERIA

CHALLENGES AND OPPORTUNITIES

# CLIMATE CHANGE AND SOCIO-ECOLOGICAL TRANSFORMATION IN NIGERIA

CHALLENGES AND OPPORTUNITIES

**Climate Change and Socio-ecological  
Transformation in Nigeria  
Challenges and Opportunities**

Copyright © 2018 Friedrich-Ebert-Stiftung

All rights reserved. No part of this book may be reproduced, stored in a retrieval system, transmitted in any form or means as electronic, mechanical, photocopying, recording, or otherwise without the prior written permission of the publishers.

ISBN: 978-978-971-018-8

First Published 2018

Published by Friedrich-Ebert-Stiftung

Copy-edited by Chizoba Vivian Nwuzor

Printed by Pamadex Global Limited

Phone Number: +234-803-332-9393

E-mail: pamglobal@yahoo.com

## **Contributors**

- **Olawale Emmanuel Olayide**

Development Practice Programme, Centre for Sustainable Development, University of Ibadan, Ibadan, Nigeria

- **Idowu O. Kunlere**

National Environmental Standards and Regulations Enforcement Agency (NESREA), Nigeria

Department of Microbiology, University of Ibadan, Ibadan, Nigeria

- **Vincent H. Ogwugwa**

Department of Microbiology, University of Lagos, Yaba, Nigeria

- **Oluwaseun O. Olubodun**

Department of Microbiology, University of Ibadan, Ibadan, Nigeria

Johann Heinrich von Thünen Institute, Bundesallee,

Braunschweig, Germany

Federal Ministry of Education, Nigeria

- **Attia M. El-Tantawi**

State Key Laboratory of Desert and Oasis Ecology, Xinjiang

Institute of Ecology and Geography, Chinese Academy of Sciences,

Urumqi 830011, China

Institute of African Research and Studies, Cairo University, Egypt

- **Bao Anming**

State Key Laboratory of Desert and Oasis Ecology, Xinjiang

Institute of Ecology and Geography, Chinese Academy of

Sciences, Urumqi 830011, China

- **Murtala Mohammed Ruma**  
Department of Geography, Umaru Musa Yar'adua University  
Katsina, Nigeria
- **Onyekachukwu Nnaemezie Ugwu**  
Institute for Peace and Strategic Studies (IPSS),  
University of Ibadan, Nigeria
- **Bolanle Wahab**  
Department of Urban and Regional Planning, University of Ibadan,  
Ibadan, Nigeria
- **Ayobola Faboyede**  
Department of Urban and Regional Planning, University of Ibadan,  
Ibadan, Nigeria
- **Isaac B. Oluwatayo**  
University of Limpopo, Sovenga, South Africa
- **Ayodeji O. Ojo**  
University of Ibadan, Ibadan, Nigeria
- **Funmilola O. Morakinyo**  
Development Practice Programme Centre for Sustainable  
Development, University of Ibadan, Ibadan, Nigeria

### **Submission of Manuscripts**

Two copies of each manuscript with an electronic copy of Microsoft Word form should be submitted to the Editorial Committee within two months of the call for manuscripts.

All papers must be double-line spaced and should not exceed 25 pages (of 5,000 – 6,000 words) excluding tables and appendices. The manuscript must include the title, author's name, address, telephone number and e-mail address.

### **References**

References and notes should be provided in a single numbered series with the numbers written in parenthesis in the order in which they ensue. They should appear at the end of the main text in numerical order.

### **Assessment**

All articles received shall be sent for independent assessment, and the result shall be communicated to the authors.

It should be noted that papers already published or sent out for publication in other journals shall not be accepted.

All correspondence should be addressed to:

The Secretary  
Editorial Committee  
c/o Friedrich-Ebert-Stiftung (FES)





## Contents

	<b>Page</b>
<b>Chapter 1</b>	<b>1</b>
Understanding the Context of Climate Change and Socio-ecological Transformation in Nigeria <i>Olayide, O. E.</i>	
<b>Chapter 2</b>	<b>17</b>
How New Climate Change Realities are Inspiring Smarter Nigerian Societies <i>Kunlere, I. O., Ogwugwa, V. H. and Olubodun, O. O.</i>	
<b>Chapter 3</b>	<b>51</b>
Climate Change in the Semi-Arid Region of Nigeria and Possible Impacts on Livelihoods <i>El-Tantawi, A. M., Anming, B. and Ruma, M. M.</i>	
<b>Chapter 4</b>	<b>88</b>
Resource Depletion and Resource Conflict in the Lake Chad Basin: Issues and Solutions <i>Ugwu, O. N.</i>	
<b>Chapter 5</b>	<b>125</b>
Reducing Flood Risk through Community Participation in Ibadan, Nigeria <i>Wahab, B. and Faboyede, A.</i>	
<b>Chapter 6</b>	<b>170</b>
The Prospects and Challenges of Waste Management Towards Improving Renewable Energy in Nigeria <i>Oluwatayo, I. B. and Ojo, A. O.</i>	

## Contents

	<b>Page</b>
<b>Chapter 7</b>	<b>184</b>
An Assessment of Industrial Estates for Socio-ecological Transformation of the Nigerian Economy: Case of Oluyole Industrial Estate in Oyo State, Nigeria <i>Morakinyo, F. O. and Olayide, O. E.</i>	
<b>Figures</b>	
<b>Tables</b>	
<b>Charts</b>	
<b>References</b>	
<b>Notes on Contributors</b>	<b>205</b>

# Contents

	<b>Page</b>
<b>Foreword</b>	xii
<b>Abbreviations and Acronyms</b>	xiv
<b>Chapter 1 .....1</b>	
<b>Understanding the Context of Climate Change and Socio-ecological Transformation in Nigeria .....1</b>	
1.1 Introduction..... 1	1
1.2 Climate Change and Socio-ecological Transformation..... 2	2
1.3 Conclusion..... 12	12
References..... 14	14
<b>Chapter 2 .....17</b>	
<b>How New Climate Change Realities are Inspiring Smarter Nigerian Societies .....17</b>	
2.1 Introduction..... 17	17
2.2 Some Local Practices in Nigeria that Predispose Climate Change..... 21	21
2.3 Impacts of Climate Change in Nigeria ..... 22	22
2.4 Climate Change Awareness in Nigeria ..... 29	29
2.5 Highlights of Nigeria’s Response to Climate Change ..... 31	31
2.6 Indigenous Adaptions and Innovations at Combating Climate Change in Nigeria..... 39	39

2.7 Recommendations .....	41
References .....	43
<b>Chapter 3 .....</b>	<b>51</b>
<b>Climate Change in the Semi-Arid Region of Nigeria and Possible Impacts on Livelihoods .....</b>	<b>51</b>
3.1 Introduction.....	51
3.2 Methodology .....	54
3.3 Results and Discussion .....	56
3.3.1 Overview of the Climate .....	56
<b>3.3.2 Trends in Temperature .....</b>	<b>60</b>
3.3.3 Long-term Period (1946-2008) Trends in the Study Area .....	61
3.4 Short-term Period (1946-1975) Trends in the Study Area .....	62
<b>3.4.1 Short Period (1976-2008) Trends.....</b>	<b>62</b>
3.4.2 Trends in Precipitation .....	65
<b>3.4.3 Wet and Dry Months .....</b>	<b>70</b>
<b>3.4.4 Aridity Index Trends in the Study Area (1946-2008) .....</b>	<b>71</b>
3.5 Possible Effects of Climate Change on Agriculture in the Study Area .....	74
3.6 Conclusions.....	80
References.....	82
<b>Chapter 4 .....</b>	<b>88</b>

<b>Resource Depletion and Resource Conflict in the Lake Chad Basin: Issues and Solutions .....</b>	<b>88</b>
4.1 Introduction.....	88
4.2 Conceptual Clarifications.....	89
4.3 Theoretical Frameworks .....	93
4.4 Methodology .....	95
4.5 Results and Discussions .....	96
4.6 Conclusion .....	116
4.7 Recommendations.....	116
References.....	121
<b>Chapter 5 .....</b>	<b>125</b>
<b>Reducing Flood Risk through Community Participation in Ibadan, Nigeria .....</b>	<b>125</b>
5.1 Introduction.....	125
5.2 Literature Review.....	129
5.3 Methodology.....	132
5.4 Results and Discussion.....	146
5.5 Conclusion and Recommendations .....	158
References.....	163
<b>Chapter 6 .....</b>	<b>170</b>
<b>The Prospects and Challenges of Waste Management Towards Improving Renewable Energy in Nigeria .....</b>	<b>170</b>
6.1 Introduction.....	170
6.2 Methodology .....	171

6.3 Renewable Energy Potentials of Nigeria.....	175
6.4 Challenges of Waste Management for Renewable Energy Generation in Nigeria.....	177
6.5 Conclusion .....	179
References.....	181
<b>Chapter 7 .....</b>	<b>184</b>
<b>An Assessment of Industrial Estates for Socio-ecological Transformation of the Nigerian Economy: Case of Oluyole Industrial Estate in Oyo State, Nigeria .....</b>	<b>184</b>
7.1 Introduction.....	184
7.2 Methodology .....	187
7.3 Results and Discussion .....	189
7.4 Effectiveness of Industrial Parks in Ibadan...	190
7.5 Assessment of the Practice of the Principle of Industrial Ecology (IE) and Industrial Symbiosis (IS) at Oluyole Industrial Parks .....	191
7.6 Assessment of the Factors Enhancing the Practice of Industrial Symbiosis (IS) in the Industrial Parks .....	194
7.7 Assessment of Environmental Preservation and Conservation by Ibadan Industrial Park Plan.....	195
7.8 Conclusion and Recommendations	198
References.....	201
<b>Notes on Contributors .....</b>	<b>205</b>

## Figures

<b>Figure 1.1:</b> Framework of Analysis of Climate Change and Socio-ecological Transformation	5
<b>Figure 3.1:</b> Location of the Study Area	52
<b>Figure 3.2:</b> Climate Regions in Nigeria	57
<b>Figure 3.3:</b> Monthly Mean Temperature Distribution in the Study Area	58
<b>Figure 3.4:</b> Monthly Rainfall Distribution in the Study Area	59
<b>Figure 3.5:</b> Trends of Annual Temperature [°C], 1946-2008	61
<b>Figure 3.6:</b> Trends of Annual Temperature [°C], 1946-1975	62
<b>Figure 3.7:</b> Trends of Annual Temperature [°C], 1976-2008	64
<b>Figure 3.8:</b> Trends of Annual Rainfall at some Stations under Study	69
<b>Figure 3.9:</b> Variation of Rainfall and Temperature According to Wet and Dry Months after Walter-Lieth, at Stations under Study (1946-2008)	72
<b>Figure 3.10:</b> Production Growth Rate of Corn, Sorghum and Millet in Nigeria (1960-2014)	76
<b>Figure 3.11:</b> Variabilities of Beans, Maize and Rice Yields (ton/h) in Katsina State, 1995-2006	77
<b>Figure 3.12:</b> Variabilities of Millet, Groundnut and Maize Yields (ton/h) in Zamfara 1995-2006	79
<b>Figure 4.1:</b> Geopolitical Configuration of the Lake Chad Basin	97
<b>Figure 4.2:</b> Lake Chad's Contribution to Food Security in the Region	104

**Figure 5.1:** Map of Ibadan Metropolitan area in the Context of Oyo State, Nigeria 133

**Figures 5.2** (a) and (b): The August 26, 2011 flood swept away the only bridge on Ona River at Apete that links Apete community to the rest of the city; a fragile bamboo bridge was constructed by the community to provide a temporary passage. 141

**Figures 5.3:** (c) Drainage channel and hydraulic structure blocked by solid 142

**Figures 5.4:** (e) Residential building constructed on river channel/flood 143

**Figure 5.5:** (i) Cleared block-lined drain at Gbekuba community, Ido LGA 154

**Figures 5.6:** (k) and (l) Reinforced concrete embankment and wall fence constructed to prevent flooding at Yale Foods Limited, and Rhema Chapel respectively at Oluyole Industrial Estate, Oluyole LGA 155

**Figure 5.7** (m): An elevated foundation wall and entrance to a building along Queen Elizabeth Road by Mokola roundabout 156

**Figure 6.1:** Household Wastes Dumped Around a Food Market in Lagos 178

**Figure 7.1:** Extract Map of Oluyole Industrial Estate in Ibadan Showing the Study Area. 188

## Tables

**Table 1.1** 7

**Table 3.1:** Location of the Stations, Annual Temperature, Annual Rainfall and the Periods 55



<b>Table 3.2:</b> Annual Temperature Trends ( $^{\circ}\text{C}$ ), Trend/Noise in the Period (1946-2008)	61
<b>Table 3.3:</b> Annual Temperature Trends ( $^{\circ}\text{C}$ ), Trend/Noise in the Period (1976-2008)	63
<b>Table 3.4:</b> Mean, Trends of Annual Rainfall (mm/decade), Trend/Noise Ratio and Coefficients of Variability (CV) at the Stations under Study (1946-2008)	67
<b>Table 3.5:</b> Mean, Trends of Annual Rainfall (mm/decade), Trend/Noise Ratio and Coefficients of Variability at the Stations under Study (1976-2008)	68
<b>Table 3.6:</b> Aridity Index, Trends, and De'Martonne Climate Type (1946-2008)	73
<b>Table 3.7:</b> Inter-annual Variability of Production (1000 Mt) and Yield (Kg/h) for Millet and Maize Crops in Katsina State from 1995 to 2006	75
<b>Table 3.8:</b> Yields Trends (ton/h/decade) of Beans, Maize and Rice and Correlation with Rainfall and Temperature in Katsina State (1995-2006)	78
<b>Table 3.9:</b> Yields Trends (ton/h/decade) of Millet, Groundnut and Maize and Correlation with Rainfall and Temperature in Zamfara State (1995-2006)	78
<b>Table 4.1:</b> Socio-economic Characteristics of Selected Countries Around the Lake Chad Basin	100
<b>Table 4.2:</b> Number of Displaced Persons	115
<b>Table 5.1:</b> Profile of Flooding in Ibadan 1902 – 2013	134
<b>Table 5.2:</b> Flood-affected Communities in Ibadan Metropolis 1924- 2016	138
<b>Table 5.3:</b> Flood-affected Communities, Sample Frame and Size	145

<b>Table 5.4:</b> Socio-economic Attributes of Respondents	148
<b>Table 5.5:</b> Perceived Causes of Flood disasters in Respondents' Communities	149
<b>Table 5.6:</b> Capability to Control a Flood Disaster	151
<b>Table 5.7:</b> Knowledge of Flood Mitigation Actions	151
<b>Table 5.8:</b> Flood Risk Reduction Measures	153
<b>Table 5.9:</b> Practiced Risk Reduction Measures Against Flood Disasters	158

<b>Table 6.1:</b> Classification of Wastes	172
--	-----

<b>Table 7.1:</b> Distribution of Companies' Waste Product Serving as Input for Other Companies	192
---	-----

<b>Table 7.2:</b> Industries which Benefit from the Principle of Industrial Ecology and Industrial Symbiosis in the Study Area	193
--	-----

<b>Table 7.3:</b> Existence of Land Use Regulations/guidelines within the Industrial Area	198
---	-----

## Charts

<b>Chart 4.1:</b> Water Distribution Outflow	98
--	----

<b>Chart 4.2:</b> Depletion of the Lake Chad in Km (1950-2010)	98
--	----

<b>Chart 4.3:</b> Estimated Population of the Lake Chad Basin	101
---	-----

<b>Chart 4.4:</b> Estimated Population Growth in the Lake Chad Basin	102
--	-----

<b>Chart 4.5:</b> Maternal Mortality and Birth Rates	109
--	-----

<b>Chart 6.1:</b> Biomass Resources.....	176
--	-----

<b>Chart 7.1:</b> Distribution of the Companies Pooling Resources Together in the Study Area	191
--	-----

<i>Chart 7.2: Distribution on How the Industries Power Their Operations</i>	195
<b>Notes on Contributors</b>	205

## Foreword

Concerns about the reality of climate change have taken many dimensions; ranging from purely scientific understanding of the complex issues that are involved to the analysis of its socio-economic and cultural impacts and response strategies and actions. The new interesting dimension is the recognition that business-as-usual is an insufficient response to today's climate challenges, and that appropriate transformation would be needed for humanity to cope well. This has brought the concept of transformation to the forefront of debates about responses to climate change. There is increasing scientific interest in understanding the dynamics of transformations in life support systems of the various ecosystems *vis-à-vis* climate change.

This book comes at an opportune time that a major global response to the reality of climate change is focused on ensuring that anthropogenically-induced increase in temperature is kept below 1.5°C of the pre-industrial era. This will obviously require changes in our lifestyles, including the use of our natural resources, improvement in energy efficiency and even the way we manage our waste to reduce greenhouse gases (GHGs) emissions, among others. A major premise of the book is the common knowledge that even if humanity managed to drastically reduce GHGs emissions, the amount already injected into the atmosphere has the inertia to make the climate system to continue to generate a climate of crisis for the next few centuries. Thus, the most promising approach is to transform our lifestyles and develop systems and means of adapting to the challenge of climate change to ensure that our development is climate resilient, ecologically stable and socially equitable.

The key message from the series of presentations in this book, *Climate Change and Socio-ecological Transformation in Nigeria: Challenges and Opportunities*, is that in the face of complex and

intricate linkages that exist between climate change and natural resource utilisation, there is the need to ensure minimal disruption of natural activities and promote environmental sustainability in the face of increasing climate risk in Nigeria. Whatever adjustments that would be needed for humanity to cope with the new climate-induced and impacted development transition, they must be such that they are equitably shared among the population with adequate gender considerations for resilience and adaptability of humankind to its ecological settings and the society.

The subject of climate change and socio-ecological transformation will remain a burning issue because climate changes, directly and indirectly, impact the humans' interaction/living and the ecosystem, and consequently, human development. This book has kick-started the discourse on the phenomenon of climate change and its implications on the biotic and abiotic means, with particular reference to Nigeria. It will make an interesting basic reading for those who are convinced that while climate change poses a number of challenges to sustainable development, tackling the challenge also provides many opportunities for humanity to achieve positive climate change-induced transformations in an equitable and sustainable manner.

*Professor Emmanuel Oladipo*  
Climate Change Expert

## Abbreviations and Acronyms

ACF	Action Against Hunger
BNRCC	Building Nigeria's Response to Climate Change
CBT	Cash-Based Transfer
CANSA	Climate Action Network for South Asia
CAR	Central African Republic
CBDRM	Community-based Disaster Risk Management
CBN	Central Bank of Nigeria
CCN	Climate Control News
CDRCR	Centre for Disaster Risk and Crisis Reduction
CIA	Central Intelligence Agency
CILSS	Permanent Inter-State Committee for Drought Control in the Sahel
COP	Conference of Parties
°C	Degree Celsius
DCC	Department of Climate Change
DFID	Department for International Development
DRC	Danish Refugee Council
DRM	Disaster Risk Management
DRR	Disaster Risk Reduction
DRRS	Disaster Risk Reduction Strategies
ECOWAS	Economic Community of West African States
EIPs	Eco-industrial Parks
EFSA	Emergency Food Security Assessment
EIA	Environmental Impact Assessment
EIA	Environmental Information Administration
ERM	Environmental Resources Management
FAO	Food and Agriculture Organisation
FCT	Federal Capital Territory
FEC	Federal Executive Council

FGN	Federal Government of Nigeria
FNC	First National Communication
FRiRJAT	Flood Risk Reduction Joint Action Team
GIZ	German Society for International Cooperation
GNCSNDR	Global Network of Civil Society Networks for Disaster Reduction
GRICCE	Grantham Research Institute on Climate Change and the Environment
GGW	Great Green Wall
GHG	Greenhouse Gas
GDP	Gross Domestic Product
IEDs	Improvised Explosive Devices
IE	Industrial Ecology
IS	Industrial Symbiosis
INDCs	Intended Nationally Determined Contributions
IDPs	Internally Displaced People
IFRC	International Federation of Red Cross
IIED	International Institute for Environment Development
IPCC	Intergovernmental Panel on Climate
ISSP	International Society of Sustainability Professionals
ITD	Inter-Tropical Discontinuity
Kg/h	kilogram per hour
Km	Kilometre
LCB	Lake Chad Basin
LCBC	Lake Chad Basin Commission
Mm	millimetre
MDA	Ministries, Departments and Agencies
MDGs	Millennium Development Goals
MEA	Millennium Ecosystem Assessment
NAAS	National Assembly

NARF	National Agricultural Resilience Framework
NASA	National Aeronautics and Space Administration
NASPA-CCN	National Adaptation Strategy and Plan of Action on Climate Change
NBS	National Bureau of Statistics
NCCP	National Climate Change Policy
NCCPRS	Nigeria Climate Change Policy Response and Strategy
NDCs	Nationally Determined Contributions
NDP	National Development Plan
NEC	National Economic Council
NEEAP	National Energy Efficiency Action Plan
NERC	Nigerian Electricity Regulatory Commission
NESREA	National Environmental Standards and Regulations Enforcement Agency
NEST	Nuclear Emergency Support Team
NEWMAP	Nigeria Erosion Watershed Management Project
NFP	National Forestry Policy
NGOs	Non-Governmental Organisations
NIID	National Industrial Integrated development
NPA	National Plan of Action
NPE	National Policy on Environment
NREAP	National Renewable Energy Action Plan
NIHSA	Nigeria Hydrological Services Agency
NIMET	Nigerian Meteorological Agency
NREEEP	Nigerian Renewable Energy and Energy Efficiency Policy
OCHA	Office for Coordination of Humanitarian Affairs
OYSEMA	Oyo State Emergency Management Agency
PHCN	Power Holding Company of Nigeria



RCS	Red Crescent Societies
REMP	Renewable Energy Master Plan
REDD+	Reduced Emissions from Deforestation, forest Degradation, conservation, sustainable management of forests, and enhancement of forest carbon stocks in developing countries
RPSR	Roadmap for Power Sector Reforms
SAP	Structural Adjustment programme
SCCU	Special Climate Change Unit
SDGs	Sustainable Development Goals
SEMA	State Emergency Management Agencies
SNC	Second National Communication
TRIMING	Transforming Irrigation Management in Nigeria
UN	United Nations
UNEP	United Nations Environment Programme
UNICEF	United Nations Children’s Fund
UNFCCC	United Nations Framework Convention on Climate Change
UNFPA	United Nations Population Fund
UNITA	National Union for the Total Independence of Angola
USIP	United States Institute for Peace
WASCAL	West African Science Service Centre on Climate
WEEE	Waste Electrical and Electronic Equipment
WFP	World Food Programme
WHO	World Health Organisation
WMO	World Metrological Organisation



# Chapter 1

## Understanding the Context of Climate Change and Socio-ecological Transformation in Nigeria

Olawale Emmanuel Olayide

Corresponding e-mail: waleolayide@yahoo.com

### 1.1 Introduction

Climate change is a global phenomenon that currently defines socio-ecological transformation in our society. Socio-ecological transformation entails the interaction of social and environmental factors in the economic development space. Socio-ecological transformation ensures that businesses are conducted to contribute to the sustainability of the resource base, promote an inclusive society and reduce the impact of climate change. Put succinctly, limiting the impact of climate change will require transformational actions in all sectors of the economy. Socio-ecological transformation requires the appropriate climate change adaptation, mitigation and resilience building.

Extreme climate changes events and society. For instance, flooding could result in damage to infrastructure such as water supply, transport and power services thereby extending some spiralling effects on the economy. Nigeria is particularly at risk of climate changes due to its low-lying coastline that is highly populated with a heavy concentration of Gross Domestic Product (GDP)-generating industries and infrastructure.

Similarly, the northern part of the country forms part of the Sahel which is at risk of further desertification and droughts. Flooding, water shortages, increased diseases and associated social disruption could

well give rise to a vicious cycle of economic degradation and social issues including declining agricultural productivity (with lower crop yields) and constraints on availability of water resources, among others (Olayide and Alabi 2018; Olayide *et al.* 2016a; Olayide *et al.* 2016b; IPCC 2015; Spurgeon *et al.*, 2009). The links between climate change and the incidence of diseases, such as malaria and cholera, are also becoming clearer (Filho *et al.* 2018).

## **1.2 Climate Change and Socio-ecological Transformation**

In Nigeria, the four main climate change-related hazards (BNRCC 2011) are:

- i. increased temperature,
- ii. change in amount, intensity and pattern of rainfall,
- iii. extreme weather events (including sea surge and drought), and
- iv. sea level rise.

These climate change-related hazards are already impacting the various sectors and activities in the Nigerian economy, including agriculture (crop and livestock); forests, biodiversity; health and sanitation; human settlement and housing; energy, transport and communications; industry and commerce; disaster, migration and security; livelihoods; and vulnerable groups (BNRCC 2011; NASPA 2011). The key impacts of climate change in Nigeria have resulted in sahelisation; loss of coastal zone infrastructure, loss of settlements, loss of agricultural land and harvests; reduced hydrocarbon extraction activities (Niger-delta case) and increased risk of oil spills; high food insecurity; negative effects on human health and lives; damaged transport routes; negative effects on electricity supply and distribution (Filho *et al.* 2018; Ngigi, 2009; Spurgeon *et al.*, 2009; Boko, *et al.*, 2007; Okali, 2004). Sahelisation has led to increased and unpredictable dry season rains,

rapid contraction of Lake Chad due to drought, which has shrunk significantly in size within the last 40 years.

Decreased agricultural productivity in the country threatens and predisposes the nation to food insecurity. Also, reduced water availability for irrigation as well as desertification of the Guinea Savannah region are impeding agricultural and livelihoods activities; how much more the increased social tensions in many parts of the country due to recurrent conflicts between farmers and pastoralists ('climate refugees') coming from the north to seek water and pasture for their herds in the southern part of the country.

Increased storm surge heights, high frequency of flooding incidences, heat waves, more violent wave action, including saline inundation of freshwater aquifers, are already causing loss of lives, infrastructure, settlements and agricultural lands and livelihoods in Nigeria. The negative impact of climate change on human health result from higher temperatures, higher humidity, increased flooding, reduced freshwater availability, increased number of pests and breeding sites, increased exposure to vector-borne (e.g. malaria) and water-borne (e.g. cholera) diseases, increased heat stress mortality and increased risk of malnutrition (due to food insecurity, shortages or famine) are all climate-laden. The increase in malaria alone is expected to impact on annual GDP growth rate negatively. On infrastructure, climate change results in torrential flooding and storms, which result in damaged transport routes, communication infrastructure, houses and damaged energy distribution network. Reduced rainfall results in reduced production of hydro-electricity, increased frequency of blackouts, low agricultural productivity and welfare loss (Olayide *et al.* 2016a; Olayide *et al.* 2016b; Adeoti *et al.* 2010).

The complexity of the challenges and opportunities of climate change and socio-ecological transformation can be represented in the anthropogenic space (human-induced factors) diagrammatically. *Figure 1.1* explains the nexus of challenges and opportunities for socio-ecological transformation in Nigeria. This human-induced relationship can enhance or limit the progress towards the achievement of the Sustainable Development Goals (SDGs). The nexus aptly shows that the challenges to socio-ecological transformation as increased climate change poses obstacles to development while the opportunities of climate change and socio-ecological transformation are typified as reduced climate change with implications for contribution to development. For instance, increased climate change resulting from changing weather patterns and extreme weather events would lead to a shortage of natural resources like water. Water shortage in hydroelectric power capacity or for irrigation impedes development in the sense that it results in low industrial capacity, food insecurity, hunger, high food prices and poverty. On the other hand, reduced climate change in terms of reforestation and production of solar-powered infrastructure and renewable energy use would lead to reliable power and economic empowerment that contribute to sustainable development, to the extent that it would reduce resource competition and communal conflicts. Similarly, climate change is not all about negativities or challenges. Climate change has the potential opportunities for promoting positive transformation from a grey economy (industrialisation based on fossil fuels) to a green economy (industrialisation based on renewable fuels). The green economy is built on low carbon and/or carbon neutral development pathways.

The socio-ecological transformation of Nigeria's economy would require focusing development priorities on the SDGs as indicated in

Climate Change and Socio-ecological Transformation in Nigeria:  
Challenges and Opportunities

**Figure 1.1:** Framework of Analysis of Climate Change and Socio-ecological Transformation

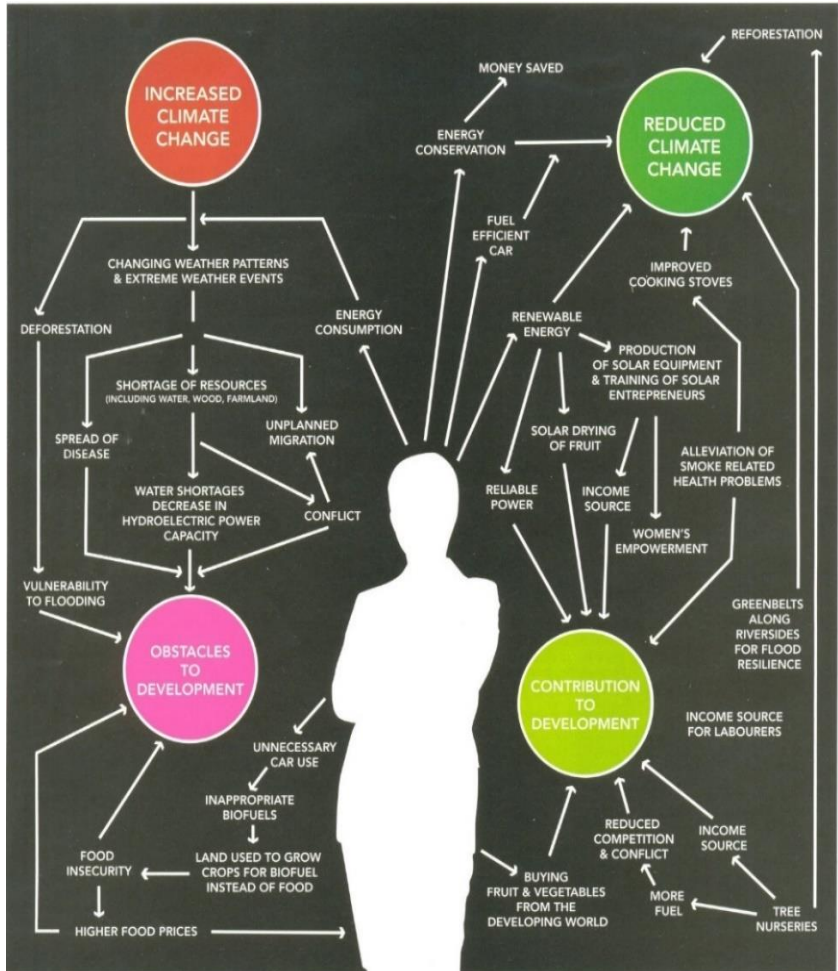

Source: Developments Magazine, Issue 46, 2009

*Table 1.1.* As emphasised in the SDGs, development of societies requires simultaneous growth in all the sectors of the economy such that the social services, environmental, economic and health management, as well as government policies are established and sustained (Nwuzor 2015). The SDGs are, thus, further classified into four dimensions, including social, economic, environmental and governance sustainability. While governance is recognised as a cross-cutting issue in sustainability, the other three dimensions can be decoupled and administered based on the country's established institutions; Ministries, Departments and Agencies (MDA). The MDA have established a policy framework of administration, monitoring and evaluation. The classification could also engender policy for domestication and operationalisation of the SDGs. For instance, a social policy framework will comprise related issues on SDGs 1-7, an economic policy framework will comprise related issues on SDGs 8-12, while an environmental policy framework will comprise related issues on SDGs 13-15. The classification of the SDGs into the various dimensions is instructive for policy development and mutual accountability.

*Table 1.1* also indicates the corresponding challenges of climate change and opportunities for socio-ecological transformation through the four dimensions of sustainability. For instance, climate change-induced social sustainability challenges include shortage of resources, vulnerability to flooding, spread of disease, conflict, food insecurity, high food prices, land used to grow crops for biofuel instead of food, changing weather patterns and extreme weather events, unnecessary car use, unplanned migration, deforestation, energy consumption, water shortages and decrease in hydroelectric power capacity. On the other hand, climate change-induced social



Climate Change and Socio-ecological Transformation in Nigeria:  
Challenges and Opportunities

**Table 1.1**

Sustainability Dimension	Sustainable Development Goals of the United Nations	Challenges to Socio-ecological Transformation	Opportunities for Socio-ecological Transformation
Social dimension	1. End poverty in all its forms everywhere	Shortage of resources, vulnerability to flooding, spread of disease	Income sources, women's empowerment, reliable power, reliable energy
	2. End hunger, achieve food security and adequate nutrition for all and promote sustainable agriculture	Conflict, food insecurity, high food prices, land used to grow crops for biofuel instead of food, vulnerability to flooding, changing weather patterns and extreme weather events	Reduced competition and conflict, tree nurseries, income sources, solar drying of fruits, green along riverside for flood resilience
	3. Attain a healthy life for all at all ages	Shortage of resources, unnecessary car use, food insecurity, spread of disease	Alleviation of related health problems
	4. Provide equitable and inclusive quality education and life-long learning opportunities for all	Conflicts, unplanned migration	Reduced competition and conflicts, women's empowerment

**Table 1.1** Continued

<b>Sustainability Dimension</b>	<b>Sustainable Development Goals of the United Nations</b>	<b>Challenges to Socio-ecological Transformation</b>	<b>Opportunities for Socio-ecological Transformation</b>
Social dimension (continued)	5. Attain gender equality, empower women and girls everywhere	Conflicts	Women empowerment
	6. Secure water and sanitation for all for a sustainable world	Shortage of resources, changing weather patterns, deforestation	Green along riverside for flood resilience, reforestation, afforestation
	7. Ensure access to affordable, sustainable and reliable modern energy services for all	Energy consumption, water shortages, decrease in hydroelectric power capacity	Fuel-efficient cars, improved cooking stoves, reliable power, renewable energy, more fuel, energy conservation
Economic dimension	8. Promote strong, inclusive and sustainable economic growth and decent work for all	Higher food prices, energy consumption, unplanned migration, shortage of resources	Reliable power, women's empowerment, production of solar equipment and training of solar entrepreneurs
	9. Promote sustainable industrialization	Energy consumption, conflict, shortage of resources	Renewable energy, reliable power

Climate Change and Socio-ecological Transformation in Nigeria:  
Challenges and Opportunities

**Table 1.1** Continued

<b>Sustainability Dimension</b>	<b>Sustainable development goals of the United Nations</b>	<b>Challenges to socio-ecological transformation</b>	<b>Opportunities for socio-ecological transformation</b>
<b>Economic dimension (continued)</b>	10. Reduce inequality within and among countries	Conflict, changing weather patterns and extreme weather events	Women's empowerment, income source, reduced competition and conflict
	11. Build inclusive, safe and sustainable cities and human settlements	Shortage of resources, vulnerability to flooding, unnecessary car use	Fuel-efficient cars, renewable energy, reduced competition and conflicts, production of solar equipment and training of solar entrepreneurs, reforestation
	12. Promote sustainable consumption and production patterns	Shortage of resources, deforestation, food insecurity, energy consumption, unnecessary car use	Reforestation, solar drying of fruits, energy consumption, reliable power

**Table 1.1** Continued

<b>Sustainability Dimension</b>	<b>Sustainable Development Goals of the United Nations</b>	<b>Challenges to Socio-ecological Transformation</b>	<b>Opportunities for Socio-ecological Transformation</b>
<b>Environmental dimension</b>	13. Promote actions at all levels to address climate change	Changing weather patterns and extreme weather events, deforestation, vulnerability to flooding, unnecessary car use	Afforestation, reforestation, fuel-efficient cars, renewable energy, production of solar equipment and training, green along riverside for flood resilience
	14. Attain conservation and sustainable use of marine resources, oceans and seas	Changing weather patterns and extreme weather events, vulnerability to flooding, water shortages, decrease in hydroelectric power capacity	Green along riverside for flood resilience
	15. Protect and restore terrestrial ecosystems and halt all biodiversity loss	Deforestation, unplanned migration, conflict.	Tree nursery, reforestation

Climate Change and Socio-ecological Transformation in Nigeria:  
Challenges and Opportunities

**Table 1.1** Continued

Sustainability Dimension	Sustainable Development Goals of the United Nations	Challenges to socio-ecological transformation	Opportunities for Socio-ecological Transformation
Governance dimension	16. Achieve peaceful and inclusive societies, rule of law, effective and capable institutions	Conflict, unplanned migration, changing weather patterns, extreme weather events vulnerability to flooding	Reduced competition and conflicts, reforestation
	17. Strengthen and enhance the means of implementation and global partnership for sustainable development	Conflicts, unplanned migration, spread of disease.	Women’s empowerment, income source, reduced competition and conflict, energy conservation, buying fruits and vegetables from a developing world.

**Source:** Author’s conceptualisation

sustainability and opportunities for socio-ecological transformation include diversified income sources, women’s empowerment, reliable power, reliable energy, reduced competition and conflict, tree nurseries, solar drying of fruits, green along riverside for flood resilience, alleviation of related health problems through health insurance, reforestation, afforestation. The opportunities are suggested

policy and priority action steps for enhancing socio-ecological transformation on social, economic and governance sustainability in Nigeria.

### **1.3 Conclusion**

The current socio-ecological development pathway in Nigeria is highly susceptible to the vagaries of climate change. The various sectors of the Nigerian economy (including agriculture, health, housing, infrastructure and services) are vulnerable to climate change.

Therefore, the socio-ecological transformation of Nigeria's economy would require adapting development priorities along with sustainability issues. The SDGs offer the potential for the development that is climate resilient. The SDGs are classified into four dimensions, which are; social, economic, environmental and governance sustainability. While governance is recognised as a cross-cutting issue in sustainability, the other three dimensions (social, economic and environmental sustainability) can be decoupled and administered based on the country's established institutions – Ministries, Departments and Agencies (MDA). The MDA have established policy framework of administration, monitoring and evaluation.

Achieving the socio-ecological transformation of Nigeria's economy would require adequate policy planning and prioritisation of the country's sustainable development objectives. While advocating for inclusive and sustainable development, the challenges to sustainable development must be considered and be adequately analysed. The green economy development pathway has inherent opportunities for sustainable development in the era of climate change. Therefore, the country would require strategic and measurable indices for assessing

Climate Change and Socio-ecological Transformation in Nigeria:  
Challenges and Opportunities

progress with a view to ensuring transformation to a green economy and the sustainable development pathways.

## **References**

- Adeoti, A. I., Olayide, O. E. and Coster, A. S. (2010): *Flooding and Welfare of Fishers' Households in Lagos State, Nigeria. Journal of Human Ecology*. Delhi: India 32(3): 161-167 (2010).
- Boko, M., Niang, I., Nyong, A., Vogel, C., Githeko, A., Medany, M., Osman-Elasha, B., Tabo, R. and Yanda, P. (2007): Africa. In: Parry, M. L., O. F. Canziani, J.P. Palutikof, P. J. van der Linden and C. E. Hanson (eds.). 2007. *Climate change 2007: Impacts, adaptation and vulnerability*. The Contribution of Working Group II to the Fourth Assessment Report of the Intergovernmental Panel on Climate Change (IPCC). Cambridge, UK: Cambridge University Press: 433-467.
- Building Nigeria's Response to Climate Change (BNRCC) (2011): *Towards National Adaptation Strategies and Plan of Action (NASPA): A Consultative Document*. Source: [http://www.nigeriaclimatechange.org/docs/2011/TowardsNASPAConsultative\\_Document-1.pdf](http://www.nigeriaclimatechange.org/docs/2011/TowardsNASPAConsultative_Document-1.pdf)
- Developments (2009): *All change: Fighting Climate Change and Poverty*. Department for International Development (DFID). *Developments Magazine Issue 46*.
- Filho, W. L., Icaza, L. E., Neht, A., Klavins, M., and Morgan, E. (2018): Coping with the Impacts of Urban Heat Islands: A Literature-Based Study on Understanding Urban Heat Vulnerability and the Need for Resilience in Cities in a Global Climate Change Context. *Journal of Cleaner Production*, 171: 140-149.



Climate Change and Socio-ecological Transformation in Nigeria:  
Challenges and Opportunities

- Intergovernmental Panel on Climate Change (IPCC) (2015): *Climate Change 2014: Synthesis Report. The Contribution of Working Groups I, II and III to the Fifth Assessment Report of the Intergovernmental Panel on Climate Change* [Core Writing Team, R. K., Pachauri and L.A. Meyer (eds.)]. IPCC, Geneva, Switzerland, 151 p. First published in 2015. Accessible via [https://www.ipcc.ch/pdf/assessment-report/ar5/syr/SYR\\_AR5\\_FINAL\\_full.pdf](https://www.ipcc.ch/pdf/assessment-report/ar5/syr/SYR_AR5_FINAL_full.pdf)
- National Adaptation Strategy and Plan of Action (NASPA). (2011): *Impacts of Climate Change on Nigeria*. Source: <http://www.naspanigeria.org/ccinfo.php>
- Ngigi, S. N. (2009): *Climate Change Adaptation Strategies: Water Resources Management Options for Smallholder Farming Systems in Sub-Saharan Africa*. The MDG Centre for East and Southern Africa, The Earth Institute at Columbia University: New York.
- Okali, D. (2004): *Climate Change and Nigeria: A Guide for Policy Makers*. Nigerian
- Environmental Study/Action Team (NEST). NEST, Ibadan, Nigeria. Source: [www.nestinteractive.org/climate\\_change\\_docs/policymakersoct25.pdf](http://www.nestinteractive.org/climate_change_docs/policymakersoct25.pdf)
- Nwuzor, C. V. (2015): *Social Dimensions of Economic Growth and Regional Integration in West Africa*, Chapter 5, Pages 156 – 192. In K. K. Simeon, J. O. Igue and S. O. Akande (Editors) (2015): *Growth and Development in West Africa*

- Olayide, O. E., Tetteh, I. K. and Popoola, L. (2016a): Differential Impacts of Rainfall and Irrigation on Agricultural Production in Nigeria: Any Lessons for Climate-Smart Agriculture? *Agricultural Water Management*. 178, 30-36.
- (2016b): Review and Analysis of Vulnerability to Rainfall Variability and Policy Responses to Agricultural Water Supply in Nigeria. *Journal of Food, Agriculture and Environment*, 14 (2): 152-155.
- Olayide, O. E. and Alabi, T. (2018): Between Rainfall and Food Poverty: Assessing Vulnerability to Climate Change in an Agricultural Economy. *Journal of Cleaner Production*, 198, 1-10.
- Spurgeon, J., Wasilewski, C., Ikpi, A. and Foster, S. (2009): *Impact of Climate Change on Nigeria's Economy*. Department for International Development (DFID) and Environmental Resources Management. Source: <http://www.scribd.com/doc/47086875/27-Impact-of-Climate-Change-on-Nigerias-Economy>

## Chapter 2

### How New Climate Change Realities are Inspiring Smarter Nigerian Societies

Idowu O. Kunlere<sup>1,2</sup>, Vincent H. Ogwugwa<sup>3</sup> and  
Oluwaseun O. Olubodun<sup>2,4</sup>

<sup>1</sup>National Environmental Standards and Regulations Enforcement Agency  
(NESREA), Nigeria

<sup>2</sup>Department of Microbiology, University of Ibadan, Ibadan, Oyo State, Nigeria

<sup>3</sup>Department of Microbiology, University of Lagos, Yaba, Lagos State, Nigeria

<sup>4</sup>Johann Heinrich von Thünen Institute, Bundesallee, Braunschweig, Germany  
Federal Ministry of Education, Nigeria

Corresponding e-mail: idowu2nice@yahoo.com

#### 2.1 Introduction

Going by Nigeria's official joining of the United Nations Framework Convention on Climate Change (UNFCCC) in 1992 and a number of other important events leading up to the 1992 Earth Summit in Rio de Janeiro, Brazil, Nigeria's top political echelons and administrators had long been aware of climate change, its impacts and threats to Nigeria being a developing country. Yet, not much was put on the ground in advance, in terms of concrete steps or national policies to adequately prepare the country to mitigate or adapt to its impacts or position the country to check the emerging global reality. In fact, in the revised 1999 National Policy on Environment (NPE) was supposed to be an elaborate document, conceptualized to reflect the major aspects of the environment; priorities and critical issues as they would affect Nigerians for the foreseeable future. Yet, it somehow missed out on identifying climate change as a major issue as evident in climate change being mentioned only once in the entire document (Ajani & Kunlere

2017). However, in the past two to three decades, we have moved from a point, pre-1992 or pre-1999, where, climate change was not a big issue, to a point, post-2010, where it has become one of the biggest global issues, it affects everyone on earth.

For example, as can be seen in *Figure 2.1*, in 2017, the research which sampled over 40,000 respondents across 38 countries reported that climate change was one of the top concerns noted by respondents. It must be noted that Nigeria’s Federal Executive Council (FEC) adopted a revised version of the NPE on 22nd February 2017 but the official

**Figure 2.1:** Major Global Threats



**Source:** Pew Research Centre

version of the revised document is yet to be released to the public. However, in the unofficial final draft of the document, climate change appeared thirty-four times, an improvement from the 1999 version. But it remains to be seen if the new document when officially released, would be a departure from the passive mention climate change had in the 1999 version.

However, in its current National Development Plan (NDP), so-called Vision 20:2020 that the Federal Government of Nigeria (FGN) adopted in 2009, some ambitious economic targets were set for the country. The plan which includes growing Nigeria's economy into one of the top 20 economies in the world in terms of GDP size by 2020, recognises climate change as an existential threat to Nigeria's economic prosperity and future development.

Nigeria's NDP; Vision 20:2020, has six main policy thrusts, namely;

- i. Bridging the infrastructure gap to unleash economic growth and wealth creation;
- ii. Optimising the sources of economic growth to increase productivity and competitiveness;
- iii. Building a productive, competitive and functional human resource base, for economic growth and social advancement;
- iv. Developing a knowledge-based economy;
- v. Improving governance, security, law and order and engendering a more efficient and effective use of resources and to promote social harmony and a conducive business environment for growth; and
- vi. Fostering accelerated, sustainable social and economic development in a competitive and environmentally friendly manner, (Nigeria Vision 20:2020 2010).

Although climate change, as a context, could be said to have entered Nigeria's national lexicon about three to four decades ago, it did not

become a topical national issue until only about a few years back. Amongst other reasons, the following could have been responsible for the oversight:

- i. limited knowledge at that time on the subject matter, climate change;
- ii. little awareness;
- iii. lack of global attention; and
- iv. the inability of the then national leaders to see far ahead.

But whatever the reason(s) was or were, the fact that many other countries did not see the challenge of climate change coming is not an excuse as to why Nigeria missed it too. It is generally believed that climate change is the greatest threat the planet faces today (Climate Action Network for South Asia [CANSAs] 2012). Gladly, the past few years have seen a re-awakening of some sort. There now seems to be a national consensus to address the threats that climate change poses to the Nigerian society. Finally, everyone is talking about it, although people at the grassroots might not yet have a full grasp of what it is about apart from the unnerving idea that the world is changing.

Arguably, Africa is the most vulnerable continent to climate change, even though it contributed the least to the events that led to climate change (International Institute for Environment Development [IIED], 2005). According to the United Nations(UN) e-learning platform on climate change, “By 2020, between 75 million and 250 million people will be exposed to increased water stress, rise in sea level that will affect major cities in low-lying coastal regions, such as Alexandria (Egypt), Cairo (Egypt), Lome (Togo), Cotonou (Republic of Benin), Lagos (Nigeria), Mattawa (Canada).” Across Nigeria today, climate change awareness is said to be gradually spreading (DCC 2018a). People at the grassroots, farmers, health professionals and governments are beginning to, more actively, leverage on various indigenous innovations, and agree on local, regional and national policies to

combat, mitigate or adapt to the impacts of climate change. But the critical questions remain:

- i. Compared to thirty years ago, how aware are Nigerians, including at the grassroots, of climate change?
- ii. What innovations and indigenous adaptations are Nigerians evolving or practising to mitigate and adapt to climate change?
- iii. Are there institutional mechanisms in place to combat climate change?
- iv. How can these indigenous innovations be institutionalised and maximised?

Understanding how indigenous innovations are being adapted, at individual, community and government-levels, to the various new climate change-induced realities on the ground in Nigeria is important for articulating policies and institutionalising programmes and incentives to enhance adaptation. This study, therefore, explores some of the leading indigenous adaptations in addressing climate change in Nigeria, and these adaptations can be institutionalised and best harnessed.

## **2.2 Some Local Practices in Nigeria that Predispose Climate Change**

Climate change presents serious emerging environmental, social and economic challenges on global and local scales (Mendelsohn *et al.*, 2006). While climate change can be induced over time by natural causes, it is accelerated by human activities such as unsustainable land use, deforestation, accelerated uptake of fossil fuels etc. (Millennium Ecosystem Assessment [MEA] 2005). Climate change has been attributed to natural and human-made activities. Some of the human-made activities include activities that contribute to greenhouse gas (GHG) emissions including burning fossil fuels, felling trees or

deforestation, indiscriminate use of agricultural fertilizers, indiscriminate waste and bush burning, failure to use energy-saving household appliances etc. (Climate Control News [CCN] 2004).

Globally, the energy sector is the most important sector in GHG emissions, contributing over 90 per cent of carbon dioxide emissions and over 75 per cent of the total GHG emissions in developed countries (Garg *et al.* 2006). In Nigeria, the risk of climate change is heightened by a number of contributing factors including poor waste management practices, dependence on fossil fuel, deforestation, and the continuous unabated flaring of gas during oil exploration activities by oil companies in the Niger-Delta region. Till this day, about 75 per cent of Nigeria's gas is flared across the oil-producing Niger-Delta region. Arguably, more than other activities, gas flaring steadily releases record amounts of GHGs into the atmosphere and poses existential threats (Nzeadibe *et al.* 2011). It must be noted, however, that due to the threats of climate change and other environmental pollution issues associated with gas flaring there have been many attempts at ending gas flaring in Nigeria. But all the attempts failed. Nigerians have endured multiple postponements in the dates to end gas flaring, beginning from the 1970s, a situation that reflects lack of full commitment on the part of the governments and the enormous influence that the oil companies wield in determining government's policies. Whilst gas flaring continues unabated, International Panel on Climate Change (IPCC) (2007) warns that non-commitment to emission reductions would hamper opportunities to achieve lower emission stabilisation targets and thus, over time, increase the risk of impacts of climate change.

### **2.3 Impacts of Climate Change in Nigeria**

Widespread impacts of climate change are being felt across all sectors in Nigeria. Many reports pointed out that these impacts could worsen in the future (Building Nigeria's Response to Climate Change [BNRCC]



2011). One estimate predicted that should appropriate adaptation mechanisms and technologies not be leveraged upon, economic losses arising from impacts of climate change in Nigeria could reach N15 trillion (US\$100 billion), which is equivalent to about between 2 and 11 per cent of Nigeria's GDP by 2020, with a further rise to N69 trillion (US\$460 billion), which is equivalent to about 6 and 30 per cent by year 2050 (Department for International Development [DFID]/Environmental Resources Management [ERM] 2009).

Climate change has a telling effect on global populations, particularly on the developing countries which are the most vulnerable, due to their poor economies and weak governance structures. Some of the most severe impacts on developing countries are more frequent and extended droughts, biodiversity depletion, changes in the vegetation type, depletion of forest resources, loss of soil fertility, increased public health risks and increase in likelihood of spread of infectious diseases, changing livelihood systems, etc. (Abaje and Giwa 2007).

Like other sub-Saharan African countries, Nigeria is vulnerable to the impacts of climate change. In Nigeria's case, the associated risks are related to areas such as agriculture, biodiversity, health and water resources. Nigeria's vulnerability to the impacts of climate change can be linked to its expansive 800 kilometres (km) coastline that is quite prone to ocean surges, heavy storms etc. Additionally, about two-thirds of Nigeria's land mass, particularly in the North, are prone to drought and desertification. Its energy resources, extensive fishing and farming culture are at a threat (Nuclear Emergency Support Team [NEST] 2004; IPCC 2007). Lake Chad, the largest lake in the Chad Basin is an economically important water source which provides water to over 30 million people along its path across four countries; Chad, Cameroon, Niger and Nigeria. However, due to climate change and a combination

of several other factors, the lake was reported to have shrunk by over 90 per cent between 1963 and 1998 (see *Figure 2.2*), although satellite images taken in 2007 showed some significant improvements in its status (United Nations Environment Programme [UNEP] 2013).

At the moment, various parts of the world are experiencing an increase in temperature and higher precipitation intensity due to climate change (Field *et al.* 2012). Localised data from the Nigerian Meteorological Agency (NIMET) also support the fact that Nigeria's climate is already changing. For example, in an extensive research which analysed data of various parameters of Nigeria's climate between 1941 and 2000, a pattern of significant fluctuations in rainfall was observed across various sample points in Nigeria. During the same period under study,

**Figure 2.2:** Satellite Images Show the Massive Shrinking in Size of Lake Chad between 1972 and 2007



**Source:** UNEP, 2003 (Atlas of our changing environment)

a significant increase in temperature was also observed in most parts of the country particularly in the North-East, North-West and South-West regions, except mainly in Jos (in North-Central regions) where a decrease in temperature which resulted in slight cooling was observed (NIMET 2008).

According to BNRCC (2011), climate change is the latest challenge for sustainable human development. Future projections say Nigeria's climate would generally get hotter (higher temperatures) with an expected increase of  $0.04^{\circ}\text{C}$  per year between 2011 until the 2046-2065 period, and a further increase to  $0.08^{\circ}\text{C}$  per year after 2050. Future projections for rainfall say a wetter climate (an average increase of 15 cm annually) is to be expected in the South as against a much drier climate (an average decrease of 7.5 cm annually) in the North-East (BNRCC 2011).

On a global scale, the average contribution of agriculture to the GDP is 4.5 per cent but in West African countries whose economies are basically agrarian, agriculture contributes an average of 30 per cent, with populations that are largely rural and highly dependent. Before the advent of oil, agriculture was the mainstay of Nigeria's economy (Udoh, 2000), and the largest employer of labour in rural areas. In 1999, more than 60 per cent of the total workforce worked in the agricultural sector (Adeoti 2002). Official figures from the Central Bank of Nigeria (CBN) showed that the agricultural sector contributed 41.2 per cent and 42 per cent to Nigeria's real GDP in 2005 and 2006, respectively (CBN 2006). In 2010, about 30 per cent of Nigeria's population was employed in the agricultural sector (Nigeria's National Bureau of Statistics [NBS] 2010). After years of unrest in the Niger-Delta region and the shrinking impacts of a national recession, recent post-recession figures put Nigeria's oil production at only 2.7 per cent of total world oil supply

(US Energy Information Administration [EIA] 2017). According to NBS, the oil sector contributed only 8.79 per cent, 8.53 per cent and 9.04 per cent to Nigeria's GDP in second quarter of 2016, first quarter of 2017 and second quarter of 2017, respectively, while in 2017, the agricultural sector made up 21.6 per cent of Nigeria's GDP (Central Intelligence Agency [CIA] 2017). According to a report by the Financial Times (FT) in 2017, oil revenues provided two-thirds of governments' revenues in Nigeria and made up about 9 per cent of Nigeria's GDP (FT 2017). Even with the advent of oil, the agricultural sector remains significant to the Nigerian economy (Amaza 2000; Okolo 2004; CBN 2010).

Going by the above points, fluctuations in rainfall, drier atmosphere, drought and other manifestations of the impacts of climate change are direct threats to the livelihoods of Nigerians, and indeed, a direct threat to West African economies (Agwu *et al.* 2011). As climate change bites harder, it impacts on livelihoods of indigenous peoples. Some of the consequences of this are that indigenous people are forced to cultivate more lands to marginally increase yield to make up for the shortfall. However, those who cannot afford more lands or the resulting increase in the cost of cultivation are forced to switch from farming to non-farming activities. So, over time, there would be fewer farmers in the community engaged in farming and related activities (Ishaya and Abaje 2008).

According to Schmidhuber and Tubiello (2007), compared to richer, developed countries, developing countries are more vulnerable to climate change because of their warmer climates which already create a slightly stressed production environment, increased exposure to weather extremes, lack of access to development fund and the paucity of know-how on climate change adaptation measures. Thus, close to 200 million people, are at risk of chronic hunger by 2100. It must be

noted in addition that amongst developing countries, sub-Saharan Africa is the most vulnerable. Global climate change will bring about a deadly increase in intensity and frequency of weather extremes such as warmer summers, colder winters, heat waves etc. which could prove fatal to global and local populations (World Health Organisation [WHO] 2003). As the earth gets warmer, and in certain instances, colder, more deaths would result. As seasonal fluctuations become more frequent due to climate change, there would be an increase in epidemics. For example, diarrheal diseases would increase as temperature increases since warmer temperatures increase the proliferation of pathogens in food and water mediums (Singh *et al.* 2001; Carlton *et al.* 2016).

Climate change poses serious public health risks to the sub-Saharanans where exposure to climate-related hazards are high and poor institutional mechanisms to manage the associated risks is rife (WHO 2003). Another impact of climate change is on aquatic life. As carbon emissions increase, ocean water becomes hotter resulting in a release of solid methane deposits on the sea floor, this would further destabilise the oceans. Furthermore, as increasingly larger amounts of CO<sub>2</sub> dissolve in seawater, it becomes more acidic, threatening aquatic life, established food chains and human survival (World Ocean Review [WOR] 1 2010). Persistent increase in the concentration of CO<sub>2</sub> will, over time, led to a reduction in crop yield (IPCC 2007).

For many decades, one of the cultural practices of nomadic cattle herders in northern Nigeria is the annual migration from the north to the south in search of greener forage and water, particularly, as grazing fields dry up and water becomes scarcer during the dry seasons or harmattan periods up north. As the cattle herders and their herds of cattle move to the south, they forage all along the way; the long periods

on the road, and to and fro the south, allow for regeneration of grasses in the north. By the time the cattle return to their usual grazing fields in the northern parts, the grazed fields would have fully regrown [recovered], and thus, would be able to adequately support the cattle for the coming months until the next annual cycle begins.

However, the onset of the full impacts of climate change has somewhat disrupted that innocuous natural cycle. New realities induced by climate change mean that drought, desertification and deforestation are recurrent and now occur at alarming rates in the north. Water is scarcer and harder to come by, grazed lands take a longer time to regenerate and can hardly support the growing population of the herds. Gradually, the cattle herders are forced to begin their annual migration to the south earlier, have to stay in the southern fields for longer periods with the hope that the fields in the north would have had enough time to fully regenerate. Due to the impacts of climate change, some northern cattle herders have now invariably made their homes in the south. The longer stays in the south has over time, evolved into foraging across various vast green fields in the south, including on farmlands privately owned and cultivated by Nigerians in the south. Each time herders lead their cattle to forage on farms, they leave trails of destructions, destroying crops worth millions of naira of food and cash crops. Thus, this unregulated open grazing, which gradually, and indeed, innocently, evolved over many decades, partly in response to a search for resources and the impacts of climate change in the core northern regions of Nigeria, have led to deadly clashes between migrating herders and indigenous farmers in the southern parts of the country, resulting in one of Nigeria's current most serious national security risks. Thus, at the root of several clashes, crisis and displacements, or their escalation, are the hunt for natural resources which have become or threatened to become scarcer due to the impacts of climate change.

## **2.4 Climate Change Awareness in Nigeria**

The first step towards climate change adaptation is awareness. Central to maximising technologies for land conservation, effective climate adaptation programmes is awareness (Doss and Morris 2001; Maddison 2006; Nzeadibe *et al.* 2011). However, being aware of the impacts of climate change does not necessarily correspond to being climate change-smart or being equipped with the skills needed to leverage on available resources to mitigate or adapt to the new realities such that the impacts of the climate change are minimised. But still, being aware of climate change is the first step to adapting to climate change. The media plays an important role in the dissemination of information on climate change, including in rural areas (Egbule 2010). The better the quality of relevant information on climate change that is readily available and accessible to the public, the better the ability of the public to adapt to climate change. The more the public can relate to the information provided, the better their response and their ability to adapt. It is thus, important, that climate change information is written in a way, manner and language that the target population can best relate to.

Furthermore, climate change awareness depends on what segment of the population you ask. Perhaps, it might be wrong as some asserted (see *Figure 2.3* below) that the majority, 70 per cent of Nigerians, are still not aware of climate change or that climate change awareness is still abysmally low in Nigeria.

One of the segments of the Nigeria population getting more and more aware of climate change, perhaps because it directly affects them and because of the threats it poses to their livelihoods and economic survival, are farmers. For these obvious reasons, farmers in Nigeria, who have been involved in farming long enough, educated or not, have had first-hand experiences of various impacts of climatic change over

**Figure 2.3:** Public Awareness of Climate Change Across the World

### Public awareness of climate change

● More than 75%   ● 50 - 75%   ● 40 - 49%   ● 30 - 39%   ● Less than 30%

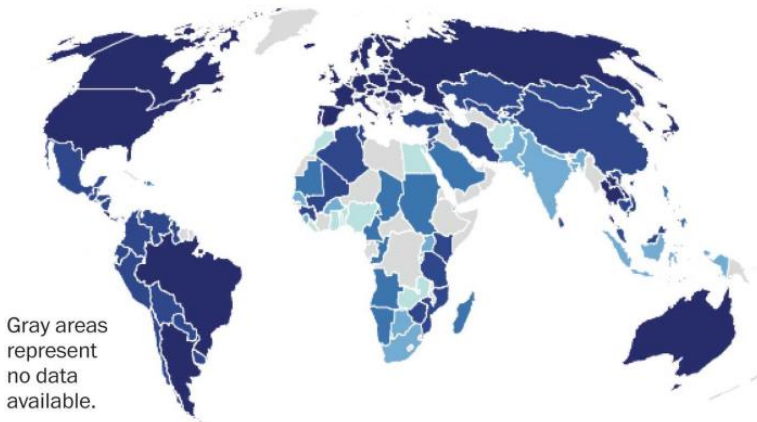

Based on data from the Gallup World Poll conducted in 2007 and 2008, from nationally representative samples in 119 countries.

Source: Nature Climate Change

THE WASHINGTON POST

**Source:** Nature Climate Change

the past few years. Apparently, these changes have impacted on the produce from their farms, increased overhead costs, reduced their net incomes, and brought about new realities, most times, negatively. Some of these farmers who are first-line ‘casualties’ of climate change may not be able to tell what the cause of the change is, give it a befitting name or specifically attribute it to climate change, but with in-depth analysis of feedback from such farmers, it is obvious that their descriptions fit textbook impacts of climate change. Thus, in farming populations, it is not unusual to find a high percentage of climate change awareness.



For instance, in their research, Nzeadibe *et al.* (2012) found that about 90 per cent of 400 respondents who were farmers were aware of climate change and its impacts. According to Nzeadibe *et al.* (2012), local farmers in Nigeria have long been aware of and mastered innovative indigenous measures for climate change adaptation. In a related study in which 60 per cent of the population in the region identified as farmers, 89.8 per cent of respondents were aware of climate change (out of which only 9.0 per cent had in-depth knowledge of its causes and other information), while 94.8 per cent of respondents had experienced one or more effects of climate change on their farming activities (Egbule 2010). In another research in which 98 per cent of the inhabitants of the villages studied were farmers, 86 per cent of respondents agreed that there had been serious changes in weather patterns and other environmental conditions which could be linked to human's activities; 84 per cent submitted that climate change deserves urgent attention; 73 per cent opined that the temperature has been on the increase; 83.5 per cent said average rainfall is on the decrease with serious fluctuations; 75 per cent agreed that the environment was getting drier to such an extent that it now affects human comfort (Ishaya and Abaje 2008).

## **2.5 Highlights of Nigeria's Response to Climate Change**

In the absence of laws, policies and regulations that directly and specifically address climate change, Nigeria had enacted different laws and policies that directly or indirectly address various environment-related issues, including climate change. There have been responses at individual, community, private sector and government levels in Nigeria on climate change. The government's response which was needed to effectively coordinate and harness the other responses, particularly at the grassroots had been missing for a long time. However, after years of somewhat slow progress in fully keying into international concerns

on climate change, domesticating and institutionalising local governance structures to coordinate efforts at mitigating and adapting to climate change, the past few years have seen various national and state governments in Nigeria acknowledge the importance of climate change and hence, have been taking critical steps in developing nationwide responses in building institutional structures at confronting climate change.

Nigeria ratified the UNFCCC statute on 29th August 1994, and the Kyoto Protocol on December 10, 2004 (UNFCCC 2018a). The UNFCCC, an international treaty which entered into force, globally, on 21st March 1994, sets out an overall framework for intergovernmental efforts to tackle the challenges posed by climate change while the Kyoto Protocol, a UNFCCC-linked international agreement which entered into force, globally, on 16th February 2005, commits its parties to achieve internationally-binding emission reduction targets (UNFCCC 2018a; UNFCCC 2018b). Whilst Nigeria is yet to domesticate the Kyoto Protocol, it submitted its first national report to the UNFCCC in 2003 and continues to progress on climate change governance (Nachmany *et al.* 2013). In 2003 and 2014, Nigeria forwarded its First National Communication (FNC) and Second National Communication (SNC) in 2014 to the UNFCCC. Nigeria continues to be an active participant at various editions of the Conference of Parties (COP), the supreme decision-making body of the UNFCCC. The COP meets annually unless it decides otherwise (UNFCCC 2018c). COP23 was held in Bonn, Germany, between 6th and 17th November 2017 (UNFCCC 2018d) while COP24 will be held from December 3rd and 14th, 2018, in Katowice, Slaskie, Poland (UNFCCC 2018e).

In June 2006, Nigeria's FEC approved the National Forestry Policy (NFP). This was followed up by its ratification by the National Economic Council (NEC) in October 2008. The aim of the policy is to

achieve sustainable forest management, which will involve an increase in environmental, social and economic benefits to all, especially the poor and vulnerable groups. The Policy is to be domesticated by Nigeria's 36 states and the Federal Capital Territory (FCT). The majority of the states have not done so. In 1992, Nigeria's military government announced the Environmental Impact Assessment (EIA) Decree No. 86, which set out the general principles, procedure and methods to enable the prior consideration of environmental impact assessment on certain public or private projects. The EIA Act had been amended in 2004 and 2014.

In 2007, Nigeria's National Assembly (NAAS) passed the National Environmental Standards and Regulations Enforcement Agency (NESREA) Act, which was subsequently signed into law by the then President, Umaru Musa Yar'adua on 31st July 2007 and published in the Federal Republic of Nigeria Official Gazette No. 92. This led to the establishment of the NESREA whose mandate is to enforce all environmental laws, guidelines, policies, standards and regulations including enforcing compliance with the provisions of international agreements, protocols, conventions and treaties on the environment to which Nigeria is a signatory: these laws include those relating to climate change. The successful establishment of NESREA in 2007 as the enforcement arm of the Federal Ministry of Environment, is perhaps Nigeria's most important step in the last decade and proof of the federal government's commitment to environmental sustainability, climate change adaptation, and broadly, sustainable development.

NESREA, through the Federal Ministry of Environment and relevant organs of the federal government and stakeholders, has, till date, gazetted 33 regulations which cut through various sectors of the Nigerian economy, and to a large extent, help to mitigate or slow down

environmental factors that could worsen climate change. Amongst these are the:

- i. National Environmental (Wetlands, River Banks and Lake Shores) Regulations, 2009;
- ii. National Environmental (Sanitation and Wastes Control) Regulations, 2009;
- iii. National Environmental (Mining and Processing of Coal, Ores and Industrial Minerals) Regulations, 2009;
- iv. National Environmental (Ozone Layer Protection) Regulations, 2009;
- v. National Environmental (Soil Erosion and Flood Control) Regulations, 2011;
- vi. National Environmental (Desertification Control and Drought Mitigation) Regulations, 2011;
- vii. National Environmental (Base Metals, Iron and Steel Manufacturing/Recycling Industries) Regulations, 2011;
- viii. National Environmental (Control of Bush/Forest Fire and Open Burning) Regulations, 2011;
- ix. National Environmental (Construction Sector) Regulations, 2011;
- x. National Environmental (Control of Vehicular Emissions from Petrol and Diesel Engines) Regulations, 2011;
- xi. National Environmental (Surface and Groundwater Quality Control) Regulations, 2011;
- xii. National Environmental (Non-Metallic Minerals Manufacturing Industries Sector) Regulations, 2011;
- xiii. National Environmental (Quarry and Blasting Operations) Regulations, 2013; and
- xiv. National Environmental (Control of Hazardous Chemicals) Regulations, 2014.

Acknowledging that, globally, the future of energy lies with renewable energy sources and their roles in mitigating against climate change, a draft of Nigeria's first Renewable Energy Master Plan (REMP) was agreed upon by stakeholders in 2005. This was then revised in 2012. However, neither the 2005 document nor its revised 2012 version succeeded in garnering enough support to win the approval of the FEC. This would later change. In August 2012, Nigeria's then President, Goodluck Jonathan launched the Roadmap for Power Sector Reforms (RPSR). In 2015, the federal government approved the Nigerian Renewable Energy and Energy Efficiency Policy (NREEEP) to spur the sustainable growth of clean energy contribution in Nigeria's electricity sector. The NREEEP is to be complemented by a National Renewable Energy Action Plan (NREAP) and a National Energy Efficiency Action Plan (NEEAP).

In 2011, Nigeria adopted the National Adaptation Strategy and Plan of Action on Climate Change (NASPA-CCN) which describes strategies, programmes and measures for 13 important economic and social sectors; and in September 2012, the Nigeria Climate Change Policy Response and Strategy (NCCPRS), also called the National Climate Change Policy (NCCP), a comprehensive strategy policy to promote low-carbon, high-growth economic development and build a climate-resilient society through the achievement of 13-sector targets. The NASPA-CCN outlined specific strategies (policies, programmes and measures) for thirteen different priority sectors/themes are:

- i. Agriculture (crops and livestock);
- ii. Freshwater resources, coastal water resources and fisheries;
- iii. Forest;
- iv. Biodiversity;
- v. Health and sanitation;
- vi. Human settlements and housing;

- vii. Energy;
- viii. Transportation and communications;
- ix. Industry and commerce;
- x. Disaster, migration and security;
- xi. Livelihoods;
- xii. Vulnerable groups; and
- xiii. Education (BNRCC 2011).

In 2014, the FGN launched the National Agricultural Resilience Framework (NARF) which seeks to minimise the effects of climate change on agricultural production and food security in Nigeria. Some other examples of climate change-related changes that Nigeria has introduced, launched, or adopted in the past few years include the Nigeria Erosion Watershed Management Project (NEWMAP), the Great Green Wall (GGW) project on afforestation, Transforming Irrigation Management in Nigeria (TRIMING), FADAMA, and REDD+.

Nigeria submitted its Intended Nationally Determined Contributions (INDCs) (or Nationally Determined Contributions – NDCs) to the UNFCCC in November 2015. On 28th March 2017, Nigeria ratified the Paris Agreement which aims to “strengthen the global response to the threat of climate change by keeping a global temperature rise this century well below 2 degrees Celsius above pre-industrial levels and to pursue efforts to limit the temperature increase even further to 1.5 degrees Celsius.”

Although Nigeria still lacks a full-fledged federal agency or parastatal on climate change, the Special Climate Change Unit (SCCU) which was domiciled within the Federal Ministry of Environment, amongst other things, mobilised the Inter-ministerial Coordinating Committee on Climate Change (Department of Climate Change [DCC] 2018a). In

December 2011, the SCCU was upgraded to the DCC under the Federal Ministry of Environment (see *Figure 2.4*) to serve as the vehicle for driving National Climate Action efforts/actions (DCC, 2018b). One of the challenges of the current system is that, in the absence of a full-fledged federal agency or parastatal on climate change, there has been a lack of definite coordination of government's activities on climate change. This also created a situation where responsibilities overlap across various existing government bodies. In 2013, Nigeria's Federal Executive Council approved for ratification, an international agreement entered between Germany, Nigeria and nine other West African, Economic Community of West African States (ECOWAS) countries in 2012 to collaborate in the review and development of climate change policies. The nine other ECOWAS member countries involved in the agreement are Benin, Burkina Faso, *Cote d'Ivoire*, Ghana, Gambia, Mali, Niger, Senegal, and Togo. That cooperation is currently in force and has led to the establishment of the West African Science Service Centre on Climate Change and Adapted Land Use (WASCAL) (Grantham Research Institute on Climate Change and the Environment [GRICCE] 2016). To further strengthen climate change response across the West African sub-region, the other remaining five members countries of ECOWAS (Liberia, Sierra Leone, Guinea, Guinea Bissau and Cape Verde) have been invited to join WASCAL (Schütte 2015).

In 2010, Nigeria's NAAS (Senate and House of Representatives) passed a harmonised bill called the National Climate Change Commission Bill amongst other things was to lead to the establishment of a Climate Change Commission to coordinate government's activities on climate change response. Many months after his receipt of the bill, Nigeria's then President, Goodluck Jonathan, withheld his assent to the bill, a development that left the bill hanging. The eighth NAAS would later re-introduce the bill. The House of Representatives passed the new

**Figure 2.4:** Management Structure of the Department of Climate Change, Federal Ministry of Environment

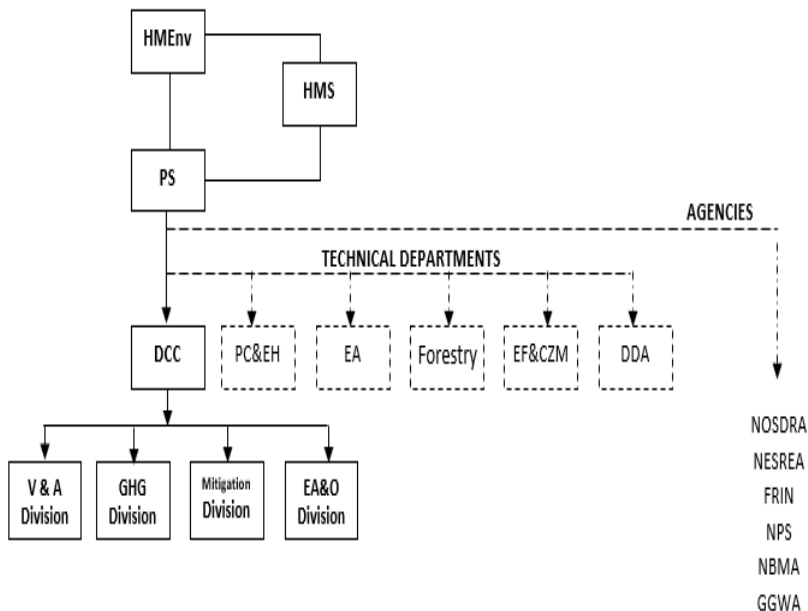

HMEnv – Honourable Minister of Environment  
 HMS – Honourable Minister of State  
 PS – Permanent Secretary  
 DCC - Department of Climate Change  
 PC&EH – Department of Pollution Control & Environmental Health  
 EA – Department of Environmental Assessment  
 EFC&CM – Department of Erosion, Flood Control & Coastal Zone Management  
 DDA – Department of Drought and Desertification Amelioration  
 NESREA – National Environmental Standards Regulatory & Enforcement Agency

V&A – Vulnerability & Adaptation Division  
 GHG – Green House Gases Division  
 Mitigation Division  
 EAO – Education, Awareness & Outreach Division  
 NPS – National Park Service  
 NBMA – National Biosafety Management Agency  
 FRIN – Forestry Research Institute of Nigeria  
 GGWA – Great Green Wall Agency  
 NOSDRA – National Oil Spillage Detection and Response Agency

Source: DCC, 2018c



bill in November 2017, which was then harmonised and passed by the Senate. The new National Climate Change Bill (HB1020) now awaits the assent of Nigeria's President, Muhammadu Buhari.

## **2.6 Indigenous Adaptions and Innovations at Combating Climate Change in Nigeria**

Innovations to climate change can be driven by various segments of society although the better aware, informed, and equipped the segment is, the better the output and applicability of the innovation. One segment often overlooked is the indigenous people. According to De Chavez and Tauli-Corpus (2008), climate change adaptation is the process of adjustment of ecological, social or economic systems to actual or expected climatic stimulus and their effects or impacts. When faced with the threats of impacts of climate change such as climate variability, droughts, floods and volatile short-term changes in local and large-scale markets, a robust adaptation strategy helps people at risk stand better chances of responding to and building safety nets that help secure food, income and livelihoods (Kandlinkar and Risbey 2000). The ability of a system, the steps it takes or the changes it undergoes to cope better with the impacts of climate change is called adaptive capacity (Glwadys 2009; IPCC 2007). With adaptation, systems respond better to climate change, without it, they become more vulnerable to it (Smit and Skinner 2002).

For many countries, particularly developing ones who are innately vulnerable to the impacts of climate change, developing an effective climate change adaptation strategy is a key issue. Strategies to reduce a community's vulnerability or increase its resilience to the impacts of climate change are called adaptations (IPCC 2007). There are different ways to address climate change impacts, but the best is to integrate

adaptation responses into development planning (Asian Development Bank [ADB] 2003).

Over the years, a number of indigenous strategies had been evolved by farmers to adapt to the impacts of climate change. These include: Use of readily accessible fodders for short-term periods;

- i. Removal of weak livestock for food;
- ii. Increasing multi-species composition of herds to increase chances of surviving extreme climatic conditions;
- iii. Movement of herds from water-stressed northern regions or during periods of drought to wetter, friendlier southern regions;
- iv. Careful selection of high-value seedlings with good resistance (to drought, diseases, pests and a variety of conditions) for the next planting;
- v. Use of tall grasses to retain soil surface nutrients that had been washed away by runoff;
- vi. Land restoration using green manure; and
- vii. Construction of stone dykes (IPCC, 2007).

In their research to assess the perception of the indigenous population in Jama'a Local Government Area of Kaduna State on climate change issues and adaptation and coping measures, Ishaya and Abaje (2008) reported a high perception (60.1 per cent) on adaptation to climate change amongst the respondents.

According to Tubiello and Rosenzweig (2008), the examples of autonomous adaptation include a shift in planting, input and harvesting schedules and cultivar and crop changes. While the examples of planned adaptation include land-use incentives, better irrigation, transport and storage infrastructure, review of land tenure arrangements and access to efficient markets. In Africa, farmers adopt practices such as zero-tilling practices in cultivation, mulching and other soil-

management techniques to regulate soil temperature, suppress diseases and harmful pests and conserve soil moisture (De Chavez and Tauli-Corpus 2008). The examples of adaptation strategies adopted by indigenous people included cultivating different varieties of crops, observing different planting dates by shortening the growing season, water maximisation by practising FADAMA farming and increasing the extent of land put into agriculture (Ishaya and Abaje 2008). In another research conducted to ascertain indigenous and emerging adaptive agricultural technologies to climate change in the Niger Delta region of Nigeria, Egbule (2010) reported that use of organic manure, cover cropping, minimum/zero tillage, mixed farming practices, mulching, increased frequency of weeding cropped land, use of inorganic manure, use of resilient crop varieties, use of chemicals like herbicides and insecticides, use of early maturing crop variety and change of planting dates were some of the adaptive technologies been used by local farmers in the region.

## **2.7 Recommendations**

From the results of various research conducted by different researchers in various parts of Nigeria, a re-occurring theme is the weak approach of indigenous people in addressing the impacts of climate change. These methods are often simple, non-standardised and non-replicative. Poverty, knowledge gap, weak administration and implementation of methods and ignorance of ways of optimising the various indigenous adaptation strategies are some of the factors that hinder effective adaptation. There is the need to focus on effective information dissemination, knowledge sharing, sustained robust and aggressive awareness creation, capacity building and training programmes, international best practices and sustainable harnessing of innovations to help Nigerians maximise emerging opportunities to mitigate and adapt to climate change. The government should strengthen existing

environmental conservation and climate adaptation programmes, introduce new specific programmes that promote participation at the grassroots in climate change adaptation and related events.

So far, some of the leading indigenous innovations and adaptations in Nigeria on climate change at individual or community level lack organisational structures and adequate quality assurance protocols. This informal and largely individual-led model leaves room for abuse, underuse, misuse and outright loss of the innovation over time such as in the event of the death of the principal (innovator). There is, thus, a need for government to evolve robust policies on capacity building and on more rigorous laboratory and field testing of indigenous adaptations, and how those with good prospects can be optimised, sustainably harnessed and preserved for future generations.

In conclusion, there is a need for institutional strengthening of awareness creation, research and policy advocacy on climate change adaptations including to address current challenges in the areas of harnessing indigenous innovations. Rather than the generalist approaches, such policies must be targeted at specific groups or segments of society with overlapping peculiarities and interests. We cannot and should not continue to prioritise foreign and borrowed climate change innovations and adaptations at the expense of indigenous ones. Future policies on agriculture, technology, environmental management, climate change etc. should reflect the realities on the ground and include the emphasis on the use of indigenous innovations and adaptations. Furthermore, climate change awareness must be sustained, while public-private partnership models for climate change financing and investments in areas of research and development, capacity building, product design and optimisation etc. must be encouraged.

## References

- Abaje, I. B. and Giwa, P. N. (2007): *Urban flooding and environmental safety: A case study of Kafanchan town in Kaduna State*. A paper presented at the golden jubilee (50th anniversary) and 49th Annual Conference of the Association of Nigerian Geographers (ANG) Scheduled for October 15–19, 2007 at the Department of Geography, University of Abuja, Gwagwalada-Abuja.
- African Development Bank (ADB) (2003): Report.
- Adeoti, A. I. (2002): *Economic Analysis of Irrigation and Rain-fed Production Systems in Kwara State, Nigeria*. Unpublished PhD thesis, Department of Agricultural Economics, University of Ibadan.
- Ajani, I. A. and Kunlere, I. O. (2017): A critical analysis of the 1999 National Policy on Environment (NPE). Distinguished Lecture Series, Department of Environmental Health Sciences, Faculty of Public Health, College of Medicine, University of Ibadan, Ibadan, Oyo State. March 10, 2017.
- Amaza, P. S. (2000): *Resource Use Efficiency in Food Crop Production in Gombe State, Nigeria*. Unpublished PhD thesis, Department of Agricultural Economics, University of Ibadan.
- Alexander, K. A., Carzolio, M., Goodin, D. and Vance, E. (2013): Climate Change is Likely to Worsen the Public Health Threat of Diarrheal Disease in Botswana. *International Journal of Environmental Research and Public Health*, 10: 1202–1230.
- Agwu, E. A., Amadu, F. O., Morlai, T. A., Wollor, E. T. and Cegbe, L. W. (2011): Agricultural Innovations for Climate Change

Adaptation and Food Security in West Africa: The Case of Nigeria, Sierra Leone and Liberia. African Technology Policy Studies Network, WORKING PAPER SERIES | No. 61.

Building Nigeria's Response to Climate Change (BNRCC) (2011): *Climate Change Adaptation Strategy Technical Reports - Nigeria*. (CCASTR) Ibadan, Nigeria: Nigerian Environmental Study/Action Team (NEST).

Climate Action Network, South-Asia (CANSAs) (2012): First regional meeting and research agenda. Bangladesh Centre for Advanced Studies.

Carlton, E. J., Woster, A. P., DeWitt, P., Goldstein, R. S. and Levy, K. (2016): A systematic review and meta-analysis of ambient temperature and diarrhoeal diseases. *International Journal Epidemiology*. 45: 117–130.

Central Bank of Nigeria (CBN) (2006a): Annual Report and Statement of Accounts for the year ended 31st December 2006.

(2010b): Central Bank of Nigeria: Statistical Bulletin, 2010 Edition.

Climate Change and Nigeria (CCN): A Guide for Policymakers (2004): David Okali and Ewah O. Eweri. Nigeria Climate Change-NEST. July 2004.

CIA, (2017): The World Factbook: GDP - Composition, by sector of origin. <https://www.cia.gov/library/publications/the-world-factbook/fields/2012.html>

Department of Climate Change (DCC), Federal Ministry of Environment (2018a): <http://climatechange.gov.ng/welcome-note-director-department-climate-change-3/>

Climate Change and Socio-ecological Transformation in Nigeria:  
Challenges and Opportunities

(2018b): <http://climatechange.gov.ng/about-us/department-of-climate-change/>

(2018c): <http://climatechange.gov.ng/management-structure/>

De Chavez, R. & Tauli-Corpus, V. (Eds.) (2008): *Guide to Climate Change*. [www.tebtebba.org](http://www.tebtebba.org)

DFID/ERM (2009): *Impact of Climate Change on Nigeria's Economy* (Abuja: DFID, 2009).

Doss, C. and Morris, M. (2001): How Does Gender Affect the Adoption of Agricultural Innovations? The Case of Improved Maize Technology in Ghana. *Agricultural Economics*. 25: 27–39.

Egbule, C. L. (2010): *Indigenous and Emerging Adaptive Agricultural Technologies to Climate Change in the Niger Delta Region of Nigeria*. MSc Thesis, Department of Agricultural Extension, Faculty of Agriculture, University of Nigeria, Nsukka.

Field, C. B., Barros, V., Stocker, T. F., Qin, D., Dokken, D. J., Ebi, K. L., Mastrandrea, M. D., Mach, K. J., Plattner, G. K., Allen, S. K., Tignor, M., *et al.*, (2012): Summary for Policymakers. In: *Managing the Risks of Extreme Events and Disasters to Advance Climate Change Adaptation: A Special Report of Working Groups I and II of the Intergovernmental Panel on Climate Change*. Pp. 1–19. New York, NY, USA, UK: Cambridge University Press: Cambridge.

Financial Times (FT) (2017): *Low Oil Price and Currency Controls Hit Nigeria Hard*. <https://www.ft.com/content/77886786-0fc9-11e7-b030-768954394623>

- Garg, A., Kazunari, K. and Puller, T. (2006): *IPCC Guidelines for National Greenhouse Gas Inventories*. 2 (1) Available at <http://www.ipcc.int>
- Glwadys, A. G. (2009): *Understanding Farmers' Perceptions and Adaptations to Climate Change and Variability*. South Africa: Environment and Production Technology Division.
- International Institute for Environment and Development, (2005): *Annual Report Focusing on the Global Challenge of Climate Change*.
- Intergovernmental Panel on Climate Change, (2007): Summary for Policymakers. In M. L. Parry, O. F. Canziani, J. P. Palutikof, P. J. van der Linden, & C. E. Hanson (Eds.), *Climate change 2007: Impacts, adaptation and vulnerability*. The Contribution of working group II to the fourth assessment report of the intergovernmental panel on climate change. pp. 7–22). Cambridge, UK: Cambridge University Press.
- Ishaya, S. and Abaje, I. B. (2008): Indigenous People's Perception of Climate change and adaptation strategies in Jema'a local government area of Kaduna State, Nigeria. *Journal of Geography and Regional Planning*. 1(8): 138-143, November 2008 Available online at <http://www.academicjournals.org/JGRP> ISSN 2070-1845
- Maddison, D. (2006): The perception of and adaptation to climate change in Africa. *CEEPA Discussion Paper No 10*. South Africa: Centre for Environmental Economics and Policy in Africa, University of Pretoria.



Climate Change and Socio-ecological Transformation in Nigeria:  
Challenges and Opportunities

- Mendelsohn, R., Dinar, A., and Williams, L. (2006): The Distributional Impact of Climate change on Rich and Poor Countries. *Environment and Development Economics* 11: 159-178.
- Millennium Ecosystem Assessment (2005):  
URL:<http://www.maweb.org/en/index.aspx>
- Nachmany, M., Fankhauser, S., Davidová, J., Kingsmill, N., Landesman, T., Roppongi, H., Schleifer, P., Setzer, J., Sharman, A., Singleton, C. S., Sundaresan, J. and Townshend, T. (2013): Climate change legislation in Nigeria: An Excerpt from the 2015 Global Climate Legislation Study: A Review of Climate Change Legislation in 99 Countries.
- Nigerian Bureau of Statistics. (2010): *Labour Force Statistics, 2010*. National Manpower Stock and Employment Generation Survey.
- Nigerian Environmental Study Team, (2004). Regional Climate Modelling and Climate Scenarios Development in Support of Vulnerability and Adaptation Studies: Outcome of Regional Climate Modelling Efforts over Nigeria. Ibadan, Nigeria NEST.
- Nigerian Meteorological Agency (NIMET) (2008): *Nigeria Climate Review Bulletin 2007*. Nigerian Meteorological Agency. February 2008. NIMET - No. 001.
- Nigeria Vision 20: 2020. (2010): *The 1st NV20:2020 Medium Term Implementation Plan (2010 – 2013)*. Volume I: The Vision and Development Priorities.
- Grantham Research Institute on Climate Change and the Environment (GRICCE), (2016): Climate Change Legislation in Nigeria: An

Excerpt from the 2015 Global Climate Legislation Study: A Review of Climate Change Legislation in 99 Countries.

Nzeadibe, T. C., Egbule, C. L., Chukwuone, N. A. and Agu, V. C. (2011a): Climate Change Awareness and Adaptation in the Niger Delta Region of Nigeria. *African Technology Policy Studies Network (ATPS) Working Paper Vol 57*. Nairobi: ATPS. Available at [www.atpsnet.org/Files/wps57.pdf](http://www.atpsnet.org/Files/wps57.pdf)

(2012b). Indigenous Innovations for Climate Change Adaptation in the Niger Delta Region of Nigeria. *Environment Development and Sustainability* 14:901–914. DOI 10.1007/s10668-012-9359-3

Okolo, D. A. (2004): Regional Study on Agricultural Support: Nigeria’s Case,” being a special study prepared for *Food and Agricultural Organization (FAO)*.

Schmidhuber, J. and Tubiello, F. N. (2007): Food Security Under Climate Change. *Proceedings of the National Academy of Sciences*. 104: 19703–19708. 167.

Schütte, G. (2015): Tackling the global challenge of climate change - German-African Cooperation in Education and Research. Opening speech by Georg Schütte at the side event: Strengthening Africa’s Competence in Combating Climate Change: African-German Cooperation in Education and Research at the 21st UNFCCC Conference of the Parties (COP 21) in Paris. <https://www.bmbf.de/de/tackling-the-global-challenge-of-climate-change-german-african-cooperation-in-education-2162.html>

Smit, B. & Skinner, M. W. (2002): Adaptation Options in Agriculture to Climate Change: A Typology. *Mitigation and Adaptation*

Climate Change and Socio-ecological Transformation in Nigeria:  
Challenges and Opportunities

- Strategies for Global Change. 7: 85-114. Netherlands: Kluwer Academic Publishers.*
- Singh, R.B., Hales, S., de Wet, N., Raj, R., Hearnden, M., & Weinstein, P. (2001): The Influence of Climate Variation and Change on Diarrheal Disease in the Pacific Islands. *Environ. Health Perspect.* 109: 155–159.
- Udoh, E. J. (2000): *Land Management and Resource-use Efficiency among Farmers in South-Eastern Nigeria*. Unpublished PhD thesis in the Department of Agricultural Economics University of Ibadan.
- United Nations Environment Programme, (UNEP) (2013): Atlas of Our Changing Environment.  
<https://na.unep.net/atlas/webatlas.php?id=58>
- United Nations Framework Convention on Climate Change (UNFCCC), (2018a): <https://unfccc.int/process/the-convention/news-and-updates>  
[http://unfccc.int/tools\\_xml/country\\_NG.html](http://unfccc.int/tools_xml/country_NG.html)
- (2018b): <https://unfccc.int/process/the-kyoto-protocol>
- (2018c): <https://unfccc.int/process/bodies/supreme-bodies/conference-of-the-parties-cop>
- (2018d): <https://unfccc.int/process/conferences/un-climate-change-conference-november-2017/about/un-climate-change-conference-november-2017>
- (2018e): <https://unfccc.int/process/conferences/katowice-climate-change-conference-december-2018/katowice-climate-change-conference-december-2018>

US EIA, US Energy Information Administration (2017): *Production of crude oil inducing lease condensate 2016* (CVS download).  
[https://www.eia.gov/beta/international/data/browser/#/?pa=00000000000000000000000000000002&c=rurvfvvtvvnv1vrvvvfvvvvfvvvou20evvvvvvvvvvvuvo&ct=0&tl\\_id=5-A&vs=INTL.57-1-AFG-TBPD.A&vo=0&v=H&start=2014&end=2016](https://www.eia.gov/beta/international/data/browser/#/?pa=00000000000000000000000000000002&c=rurvfvvtvvnv1vrvvvfvvvvfvvvou20evvvvvvvvvvvuvo&ct=0&tl_id=5-A&vs=INTL.57-1-AFG-TBPD.A&vo=0&v=H&start=2014&end=2016)

World Health Organization (WHO), (2003): *Climate Change and Human Health—Risks and Responses*. Geneva, Switzerland: World Health Organization Available online:  
<http://www.who.int/globalchange/publications/cchhbook/en/>

World Ocean Review (WOR) 1, (2010): *How Climate Change Alters Ocean Chemistry*, Chapter 2 in *Living with the Oceans*. A report on the state of the world's oceans.

## Chapter 3

### **Climate Change in the Semi-Arid Region of Nigeria and Possible Impacts on Livelihoods**

Attia M. El-Tantawi<sup>1,2, a</sup>, Bao Anming<sup>1, b</sup> and  
Murtala Mohammed Ruma<sup>3, c</sup>

<sup>1</sup>State Key Laboratory of Desert and Oasis Ecology, Xinjiang Institute of Ecology and Geography, Chinese Academy of Sciences, Urumqi 830011, China

<sup>2</sup>Institute of African Research and Studies, Cairo University, Egypt

<sup>3</sup>Department of Geography, Umaru Musa Yar'adua University Katsina, Nigeria

<sup>3, c</sup> Corresponding author's e-mail: murtala.mohammed@umyu.edu.ng

#### **3.1 Introduction**

Climate change is every deviation from a normal value and status, having significance according to the actual use of statistical tests. In addition, there are other terms for describing climate (e.g. using variability, trend, oscillation, periodicity and fluctuation). Climate variability means the lack of a consistent or fixed pattern inherent in the stationary stochastic process approximating the climate on a scale of a few decades (Almabruk 1995). The variations involve changes in the magnitude of the annual or decadal values and the mean is constant, while in the change, both the mean and the variance are changing with time (Donaire 2000). The term, trend, denotes climate change characterised by a smooth, monotonic increase or decrease of average values over the period of record.

Climate change is the most serious environmental challenge that threatens developed and less developed countries; it has reached a critical magnitude with a serious impact on societies, human welfare

and quality of human life (Domroes 1996). Since the 1950s, many of the observed changes are unprecedented over decades to millennia. The atmosphere and the oceans have warmed, the amounts of snow and ice have diminished, seas' levels have risen and the concentrations of GHGs have increased (IPCC 2013) causing the increase of surface air temperature and results in general changes of the climate system (Schaefer 2001).

Agriculture in the north-western region of Nigeria, which comprises seven states (traced in bold ink in *Figure 3.1*), is mostly rain-fed. The increases in the variability of temperature and rainfall affect the crops yield and alter the composition of grasslands. In addition, the short growing season results in food and water shortages. So, this study discussed the change of climate 'temperature and rainfall' and its possible impacts on agriculture.

**Figure 3.1:** Location of the Study Area

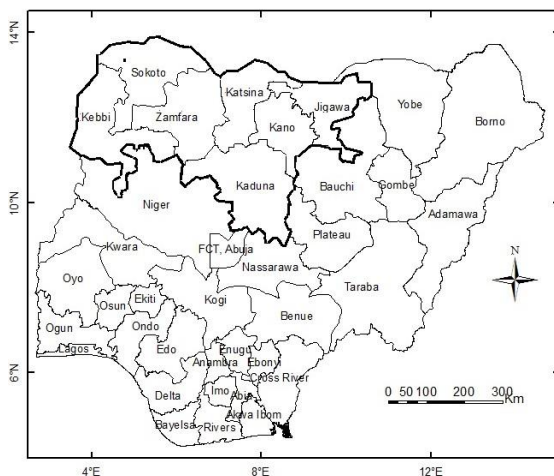

Source: Macmillan Nigeria Secondary Atlas, 2006

Although many studies about climate were carried out, only a few studies have been conducted on climate change and its possible effects on agriculture in the north-western region of Nigeria. Most of the studies carried out so far were based on the analysis of climate data:

- To describe any changes in season duration, rain-days per season and rainfall amount per rain-day in the north-east arid zone of Nigeria using daily rainfall records for 1961-1990 for Nguru, Potiskum and Maiduguri in Nigeria and Maine Soroa in Niger (Hess *et al.* 1995);
- Different aspects of droughts and rainfall variability at several timescales and the dynamics of water supply and use in a rural village in north-eastern Nigeria were studied by Tarhule (1997);
- The chain of interactions between climate change, drought condition and food production in Nigeria was studied by Emeka (2009);
- Ayansina and Odeyemi (2009) examined and mapped the spatiotemporal variation in rainfall in Guinea Savanna of Nigeria using GIS technique;
- Sowunmi and Kintola (2010) investigated the changes in climatic elements and agronomic parameter (maize hectare and output) for maize production in different ecological zones of Nigeria from 1980–2002;
- Studies were also carried out to investigate recent rainfall variability in northern Nigeria (El-Tantawi 2011);
- El-Tantawi and Ibrahim (2011) worked towards a comprehensive approach to addressing the potential impacts of climate change on biodiversity in northern Nigeria;
- El-Tantawi (2012) studied the effects of climate on human's comfort and health in the north-western region of Nigeria; and
- El-Tantawi (2013) studied the effects of growing season variations on food crop yields in Sokoto State, Nigeria.

New studies are particularly needed to examine the temporal and spatial trends of temperature and rainfall over long time periods in order to identify any change in climate with emphasis on its possible effects on agriculture. Such studies will help decision-makers to reduce the negative effects of climate change on the study area.

The main aim of this study, therefore, is to investigate the recent climate change (1946-2008) and its possible effects on agriculture in the north-western region of Nigeria, with emphasis on the following:

- overview of the climate in the study area;
- evaluation of recent spatial and temporal temperature trends in comparison to the global one;
- investigation of the temperature trends which have occurred in two periods, long-term period (1946-2008) and short-term period (1976-2008);
- examination of the rainfall trends and variability in the study area;
- a study of the aridity index and changes of wet and dry months; and
- finding out the possible effects of climate change on agriculture using the relationship between the change rate of some crops yield and yield variability in Zamfara and Katsina states.

### **3.2 Methodology**

Homogeneous monthly temperature and rainfall data at eight meteorological stations scattered in the study area were collected over 62 years (1946-2008) from NIMET, Abuja (*Table 3.1*). The reference data of the global temperature anomalies was taken from IPCC, 2001, 2007 and 2013. Agricultural data were captured from the NBS, Nigeria, FAO statistical yearbooks and [www.indexmundi.com/agriculture](http://www.indexmundi.com/agriculture).



Different statistical methods and diagrams<sup>1</sup> were used in order to investigate the temporal and spatial temperature and rainfall changes. The least squares method, (Thom 1966), was applied to compute the trends of temperature based on the annual, minimum, maximum and annual rainfall from 1946 to 2008.

**Table 3.1:** Location of the Stations, Annual Temperature, Annual Rainfall and the Periods

Station	Lat.	Long.	Mean annual Temperature °C	Total Annual Rainfall (mm)	Period
Kaduna	10.28	7.25	25.1	1220.8	1946-2008
Kano	12.00	8.31	26.2	877.7	1946-2008
Sokoto	13.07	5.23	22.2	669.2	1979-2008
Katsina	13.00	7.32	26.3	622.8	1946-2008
Zaria	11.01	7.44	25.3	1028.9	1946-2008
Gusau	12.12	6.40	26.6	907.8	1953-2008
Yelwa	10.48	4.42	27.8	997.9	1946-2008

**Source:** Nigerian Meteorological Agency, (NIMET) Abuja

Subsequently, a trend test based on a trend-to-noise ratio after Schoenwiese (1992) (total trend/standard deviation) was computed to detect linear or non-linear trends, T/N ratio of >1.96 can be regarded as

---

<sup>1</sup> Climate diagrams are brief summaries of average climatic variables and their time course.

a significant trend at a 95 per cent confidence level confidence. The aridity index after De'Martonne, which is given by

$$AI = R / (T+10) \text{ where } R = \text{annual rainfall mm,}$$

$$T = \text{mean annual temperature } ^\circ\text{C}$$

was applied to find out the trend of aridity, which can affect rain-fed agriculture. Wet and dry months after Walter-Lieth were examined by

$$\text{the correlation } R=2T$$

$$\text{where } R = \text{annual rainfall mm,}$$

$$T = \text{mean annual temperature } ^\circ\text{C}$$

(Domroes and Ping 1988) for computing, respectively, wet dry months at all stations under study and to compile the corresponding diagrams. The correlation coefficient (after Pearson) was computed between temperature, aridity, rainfall and yield of some crops in Zamfara and Katsina states, as well as the production growth rate of corn, sorghum and millet in Nigeria to investigate the possible effects of climate change on agriculture in the study area.

### 3.3 Results and Discussion

Based on the information gathered, the subsequent discuss looks at the overview of the climate and the trends of temperature in the study area. The discuss analyses the results of the obtained study data.

#### 3.3.1 Overview of the Climate

According to Koeppen's climate classification, the climate in the north-western region of Nigeria is commonly described as semiarid (BSh) or steppe climate in the northern parts, and tropical wet and dry (Aw) or Savanna climate in the southern parts of the study area (*Figure 3.2*). *Figure 3.3* shows that the study area is characterised by high temperature throughout the year with the annual average varying from 27.8°C at Yelwa in the south-west and 22.2°C at Sokoto in the north-west throughout the year, with the observation that the temperature decreases during the rainy season. It was also observed that the hottest

months were April and May, while the coldest months were January and December at most stations.

**Figure 3.2:** Climate Regions in Nigeria

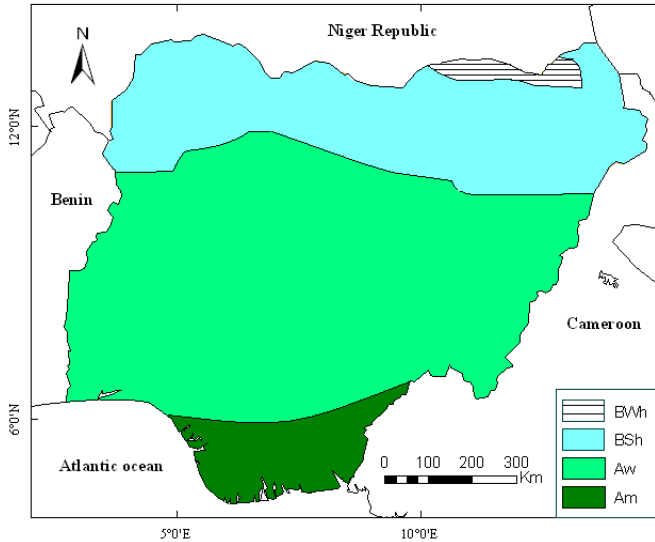

**Source:** Kottek, *et al.*, 2010

Concerning the rainfall, the dry season starts usually from October to April and it is characterised by the northern-east winds blowing from the Sahara. Hence, the weather turns dry cool and dusty when those winds are strong. North-western Nigeria receives rainfall from the south-western winds, which invade the country from the Gulf of Guinea coast. Rainfall during the wet season (summer) is usually less than 1,000 millimetres (mm) at most stations in the northern parts, while the study area in its southern parts receives more than 1,000 mm/year (El-Tantawi 2012). The moist airstream is overlain by the north-east

trade winds, which originates from the Sahara and is thereby dry and dust-laden (Olaniran 2002).

**Figure 3.3:** Monthly Mean Temperature Distribution in the Study Area

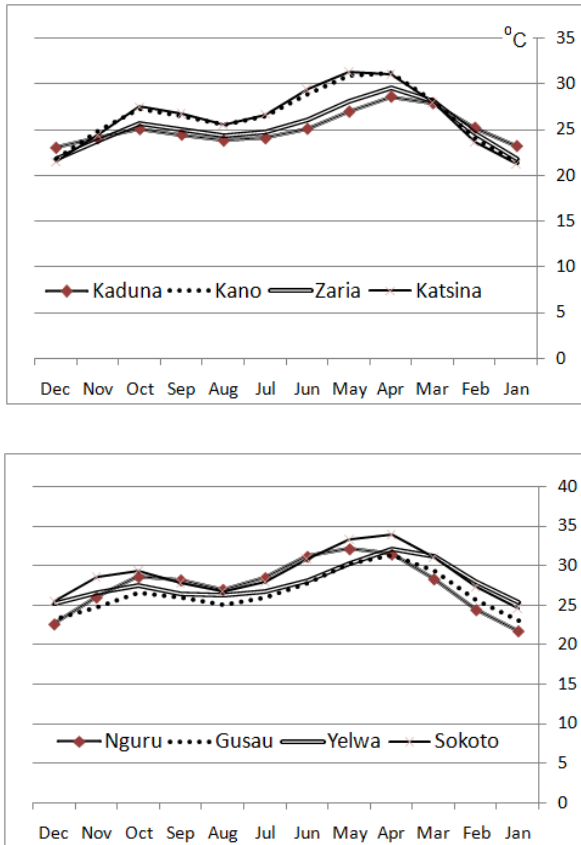

**Data source:** Nigerian Meteorological Agency, Abuja

The Harmattan, which blows during the dry season is a cold, dry and

dusty wind and brings about a considerable drop in the relative humidity, making the weather rather invigorating (Reuben 1981). The zone of contact of the two air masses at the earth's surface is a zone of moisture discontinuity commonly known as the Inter-Tropical Discontinuity (ITD) zone. The ITD advances inland as far as 22-25°N in August at the margin of the Sahara considerably beyond Nigeria's northern border, while it does not retreat equator-ward beyond 4°N latitude during the dry season (Olaniran 2002).

It can be observed from *Figure 3.4* (below) that the rainy season starts usually in late May and June in the north and in the late April in the south, while it ends by October at most stations under study. The wettest month in the study area is August at all stations except for Sokoto,

**Figure 3.4:** Monthly Rainfall Distribution in the Study Area

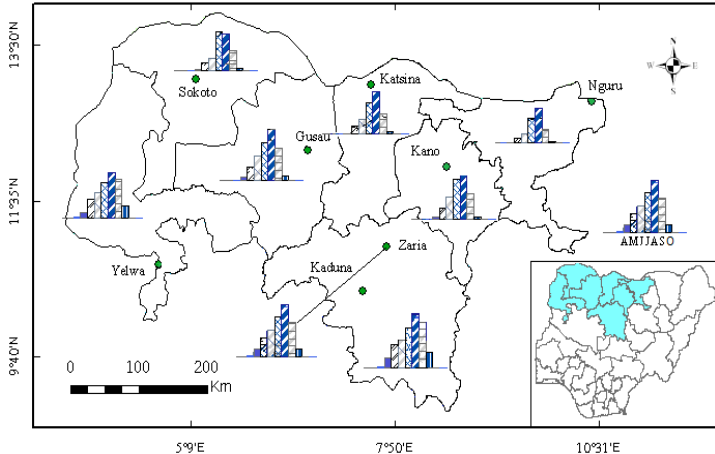

**Data source:** Nigerian Meteorological Agency, Abuja

which its wettest month is July. In the study area, two factors: the latitudinal position and its interior location away from the sea, determine the characteristics of climate which is hot and dry for most of the year and one short rainy season (Reuben 1981).

### **3.3.2 Trends in Temperature**

According to IPCC's third assessment report 2001, about climate change, it is clearly identified that the 20<sup>th</sup> century was the warmest century during the past 1,000 years; it was also shown that warming pronouncedly occurred over two periods, 1910-1945 and 1976-2000. In addition, the 1990s was the warmest decade of the millennium. Global air surface temperature increased by 0.62°C over 1901-1997 (Jones *et al.* 1999).

According to IPCC (2001) report, the average global air temperature has increased by 0.6°C in the 20<sup>th</sup> century. The warming rate in the more recent period 1976-2000 (0.17°C/decade) has been slightly larger than the rate of warming during the period 1910-1945 (0.14°C/decade). The year 2005 was the warmest year according to the National Aeronautics and Space Administration (NASA) scientists. 1998, 2002, 2003 and 2004 followed as the next four warmest years worldwide, since the 1890s.

Linear trends and their significance were compiled for annual, minimum and maximum temperature for all stations under study over the period 1946-2008 as a long-term period and over the periods 1946-1975 and 1976-2008 as short-term periods. Strongly increasing trends of temperature can be observed in almost all parts of the study area in the more recent periods. Because of the high inter-annual variability only some of the computed trends are linear, nevertheless, most trends are significant.

### 3.3.3 Long-term Period (1946-2008) Trends in the Study Area

Annual temperature trends were calculated for the six stations (Kano, Katsina, Yelwa, Gusau, Kaduna and Nguru) under study for the long-term period (1946-2008). *Figure 3.5* and *Table 3.2* show that all the

**Figure 3.5:** Trends of Annual Temperature [ $^{\circ}\text{C}$ ], 1946-2008

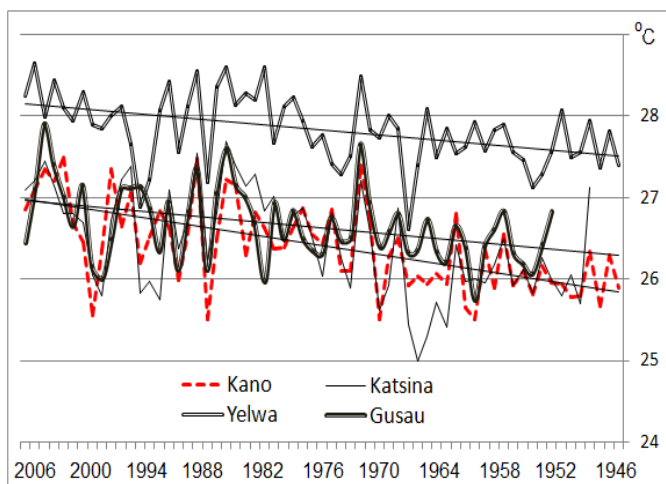

**Data source:** Nigerian Meteorological Agency, Abuja

**Table 3.2:** Annual Temperature Trends ( $^{\circ}\text{C}$ ), Trend/Noise in the Period (1946-2008)

Item	Katsina	Kaduna	Kano	Yelwa	Gusau	Nguru
Trend/decade	0.18	0.17	0.17	0.10	0.10	0.30
Trend/Noise	1.50	1.95	1.98	1.44	1.06	2.10

**Data source:** Nigerian Meteorological Agency, Abuja

trends from 1946-2008 were positively ranged between 0.10 at Yelwa in the west and Gusau in the middle of the study area and 0.30°C/decade at Nguru in the east. But most of these trends were not linear because of the strong annual temperature anomaly. Based on the T/N ratio, only Kano and Nguru stations' >1.96 can be regarded as a significant trend at a 95 per cent level of confidence. Comparing the trends in the period 1946-2008 with the global observation (IPCC 2013), it can be observed that all reference stations correspond to the global trend.

### 3.4 Short-term Period (1946-1975) Trends in the Study Area

Temperature data were analysed at three stations in the study area for the period 1946-1975, weak temperature trends have been observed at Kano and Yelwa, while at Kaduna, it was no trend of temperature (*Figure 3.6*, below). Comparing the trends in this period with the globe, the trends correspond to the global trend, which reflected none and weak trends during this period (IPCC 2001).

**Figure 3.6:** Trends of Annual Temperature [°C], 1946-1975

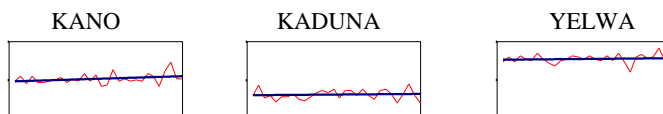

**Data source:** Nigerian Meteorological Agency, Abuja

#### 3.4.1 Short Period (1976-2008) Trends

Each of the last four decades has been successively warmer at the earth's surface than any preceding decade since 1850. In the northern hemisphere, 1983–2012 was the warmest 30-year period of the last 1400 years. The rate of warming over the period (1998–2012) 0.05°C/decade, which begins with a strong El Nino, is smaller than the



rate calculated (1951–2012) 0.12°C/decade (IPCC 2013). As for the study area, the temperature data at six stations have been analysed in the period (1976-2008) showing strong positive trends at all stations ranged between 0.40°C/decade at Zaria in the south and 0.02°C/decade at Katsina in the middle north of the study area (*Table 3.3* and *Figure 3.7*, below). But all the trends except at Zaria were not linear and not significant based on the T/N ratio. Comparing the trends in the period 1946-2008 with the global observation trend (IPCC 2013), all reference stations corresponding to the global trend have been noted over a more recent period (1976-2008).

As for the minimum and maximum temperature trends, the global mean minimum temperatures increased at nearly twice the rate of maximum temperatures from 1950-1993. The rate of temperature increased during this time has been 0.1 and 0.2 °C/decade for the maximum and minimum temperatures respectively (IPCC 2001). For the study area, the trends were investigated over the long-term period 1946-2008 and the short-term period 1976-2008 at different stations (Kaduna, Gusau, Kano and Katsina), the maximum temperature trends were positive in both periods, but the trends were strong in the more recent short period.

**Table 3.3:** Annual Temperature Trends (°C), Trend/Noise in the Period (1976-2008)

Item	Katsina	Zaria	Kano	Yelwa	Gusau	Sokoto
Trend/decade	0.02	0.4	0.1	0.06	0.12	0.28
Trend/Noise	0.12	2.6	0.6	0.45	0.82	1.79

**Data source:** Nigerian Meteorological Agency, Abuja

Figure 3.7: Trends of Annual Temperature [ $^{\circ}\text{C}$ ], 1976-2008

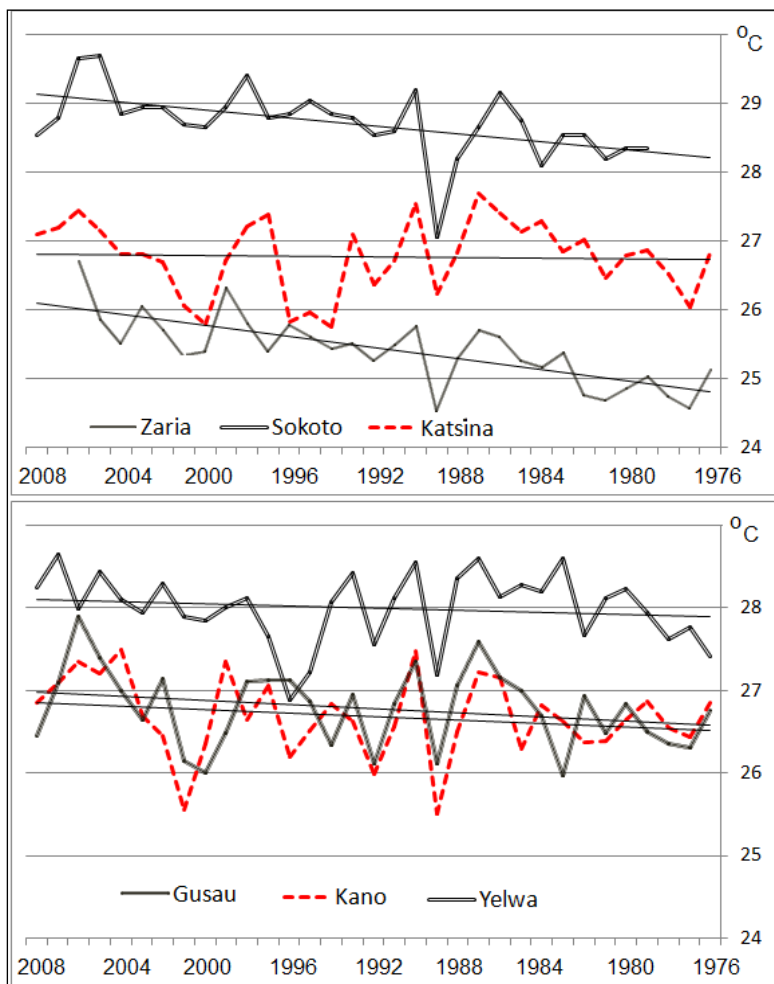

Data source: Nigerian Meteorological Agency, Abuja

For the minimum temperature trends, it has been observed that the trends were positive in both periods, the trends were strong in the period 1976-2008 at Zaria and Gusau, while they were weaker at most stations. All reference trends corresponding to the global ones have been noted over both maximum and minimum temperatures and over both investigated periods. The analysis of the mean daily maximum and minimum temperatures continue to support a reduction in the diurnal temperature range in many parts of the world.

### **3.4.2 Trends in Precipitation**

Agriculture has been the most essential sector of the economy in the study area. Rainfall is considered the primary input for crop yield as the agriculture is mostly rain-fed, so any significant variability in the amount of annual rainfall could have an equally significant effect on agricultural production. Rainfall shows a more complex structure over time and space; increasing and decreasing trends were computed. The IPCC (2001) pointed out that rainfall in Africa exhibits high inter-decadal variability throughout north Africa, south of the Sahara, a pattern of continuous aridity since the late 1960s. The pattern is most persistent over the western parts, the driest period was in the 1980s with some recovery occurring during the 1990s (Folland *et al.* 2001). During 1960-1969, the rainfall anomaly pattern dramatically reversed with rain deficit observed for most of Africa (McCarthy *et al.* 2001). The temporal change of global rainfall is directly attributed to the changes in the temperature and its effect on the global air pressure systems and air masses movements (Ritter 2003).

For the north-western region of Nigeria, the trends for the annual rainfall for all stations under study for both 1946-2008 and 1976-2008 periods have been computed. *Table 3.4* and *Figure 3.7* show that the trends in the long-term period (1946-2008) were negative at five stations out of the eight stations under study ranged between -42 mm/decade at Nguru in the north-east and -12 mm/decade at Zaria in

the south. While the positive trends were at Sokoto in the north-west, Kano in the north and at Yelwa in the south-west which registered the lowest positive trend (8 mm/decade). The variability in this period ranged between 33 per cent (very high) and 16 per cent (medium) at Kaduna, because of the very high inter-annual variability of rainfall, all computed trends were not significant according to trend/noise ratio.

The rainfall variability was expressed by coefficients of variability (standard deviation/annual mean) which is used with ratio scale variables where zero is an absolute zero point, i.e.

0 = nil, very low =  $< 0.1$ , low =  $0.1-0.2$ , medium =  $0.2-0.3$ ,

high =  $0.3-0.4$ , and very high =  $>0.4$  (Broms, 2004).

*Table 3.4* (below) and *Figure 3.7* show that the trends on long-term period (1946-2008) were negative at five stations out of the eight stations under study. They ranged between -42 mm/decade at Nguru in the north-east and -12 mm/decade at Zaria in the south. While the positive trends were at Sokoto in the north-west, Kano in the north and at Yelwa in the south-west, which registered the lowest positive trend (8 mm/decade). In trying to define a wet season or a season of reliable rainfall, it is necessary to consider not only the amount of rainfall but also its variability (Lockwood 1974), the variability in this period ranged between 33 per cent (very high) and 16 per cent (medium) at Kaduna. Given the very high inter-annual variability of rainfall, all the computed trends were not significant according to trend/noise ratios. In general, it was observed through a statistical analysis of rainfall data in the study area that rainfall was characterised by high spatial and temporal variability and the trends at most stations were negative in the long-term period (1946-2008).

**Table 3.4:** Mean, Trends of Annual Rainfall (mm/decade), Trend/Noise Ratio and Coefficients of Variability (CV)<sup>2</sup> at the Stations under Study (1946-2008)

Station	Mean mm	Variability Coefficient (%)	Trend/decade	Trend/Noise
Kano	873	33	52	1.20
Katsina	614	28	-40	-1.60
Yelwa	998	18	08	0.30
Zaria	1049	16	-12	-0.47
Gusau	907	25	-20	-0.48
Kaduna	1217	16	-26	-0.90
Nguru	479	28	-42	-1.83
Sokoto	627	19	67	1.60

**Data source:** Nigerian Meteorological Agency, Abuja

Different patterns of annual rainfall trends have been computed over the more recent period (1976-2008) in the study area (*Table 3.5*, below). The results show that positive trends prevail at all the stations scattered over different parts of the north-western region of Nigeria except at Kaduna, which registered no trend during this period. The highest was 76 mm/decade at Yelwa, and the lowest trend was 5 mm/decade at Nguru.

---

<sup>2</sup> The CV is the ratio of standard deviation to the mean. It is expressed as a percentage. A higher value of CV means a greater level of dispersion around the mean. See <https://www.insee.fr/en/metadonnees/definition/c1366>

**Table 3.5:** Mean, Trends of Annual Rainfall (mm/decade), Trend/Noise Ratio and Coefficients of Variability at the Stations under Study (1976-2008)

Station	Mean mm	Variability Coefficient (%)	Trend/Decade	Trend/Noise
Sokoto	627	19	67	1.59
Katsina	529	28	24	0.52
Yelwa	986	20	76	1.23
Zaria	1,026	16	38	0.74
Gusau	874	30	56	0.67
Kaduna	1,151	16	00	0.02
Nguru	400	27	05	0.09

**Data source:** Nigerian Meteorological Agency, Abuja

Although the annual rainfall shows positive trends at all the stations, they were interrupted by multi-year anomalies over the study period. Also, as observed, it is obvious that the variability of rainfall alters over time, being greater over the more recent period.

Applying a 10-year low-pass filter, it has also been observed that high inter-decadal variability occurred at all the stations, but they were lower than inter-annual variability (*Figure 3.8* below). *Table 3.5* shows also that all annual trends of rainfall were non-linear with trend-to-noise ratios  $< 1.96$  at 95 per cent level of confidence. These were because of the relatively high values of the standard deviation that express high inter-annual variability, which can be seen by more frequently alternating years with the above-below normal totals; simultaneously,

coefficients of variability ranged from 16 per cent (medium variability) at Zaria and Kaduna in the south and 28 per cent (high variability) at Katsina in the north. As for spatial rainfall variability, the mean values of the variability coefficient show remarkably large spatial differences.

**Figure 3.8:** Trends of Annual Rainfall at some Stations under Study

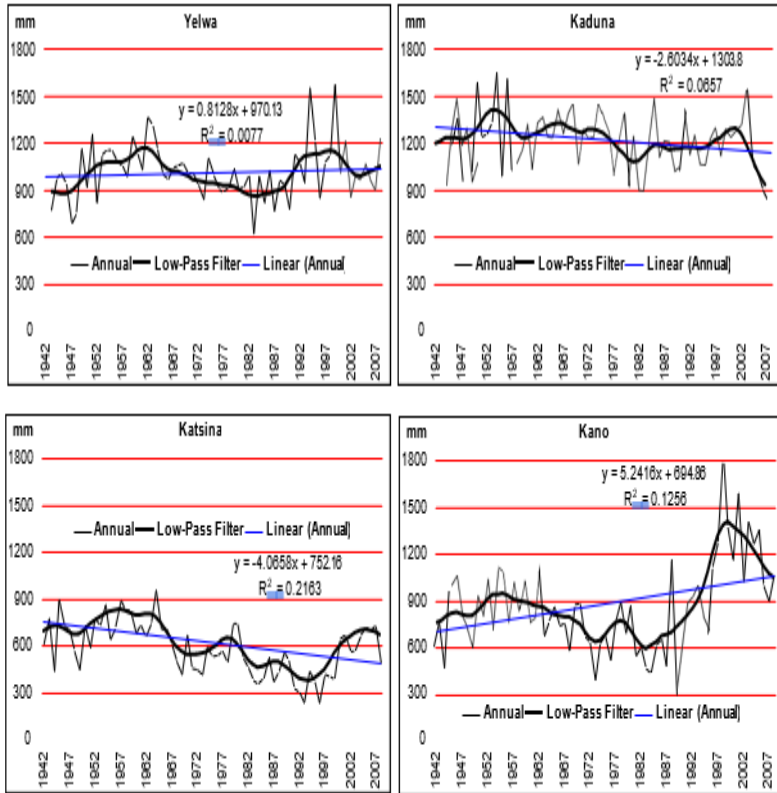

**Data source:** Nigerian Meteorological Agency, Abuja

The northern stations experienced high variability; 28 per cent, 28 per cent, 25 per cent at Katsina, Nguru and Gusua respectively, while lower variability was observed in the southern stations; 18 per cent, 16 per cent, 16 per cent at Yelwa, Kaduna and Zaria respectively, and medium in the west; 19 per cent at Sokoto. Spatial differences in rainfall trends have been detected, while positive trends prevailed at all the stations. The trends were higher in the west than in the northern and eastern parts of the study area. The periodic fluctuations of the rainfall in Nigeria can be ascribed to the fluctuations of the ITD. Whenever the ITD advances far inland, the whole country enjoys heavy rainfall as it drags along the tropical maritime air far inland: on the contrary, when the ITD fails to advance far inland the air is restricted in depth and to the lower latitudes.

That means a reduction in the amounts of rainfall in the north and drought conditions may prevail in the interior whilst at the same time the areas south of the ITD may enjoy excessive rain. The whole of the shifting pattern of the ITD cannot be viewed in isolation but rather as part of the fluctuations in the global atmospheric circulation systems (Oguntoyinbo 1983).

### **3.4.3 Wet and Dry Months**

Underlining the pronounced seasonality of rainfall and temperature in the study area, the annual variation of wet and dry months can be considered as a major climatic characteristic (Domroes and Ping 1988). Wet and dry months represent relative rather than absolute terms. Hence climatic diagrams developed by the Walter-Lieth method make an easy definition of wet and dry months; diagrams are based on the equation:  $N \text{ (mm)} = 2T \text{ (}^\circ\text{C)}$ . The diagrams compiled show the variation of the mean temperature and mean rainfall from 1946 to 2008.



When the curve of rainfall falls under the temperature curve, arid months occur, but when the temperature curve falls under the rainfall curve, wet months occur. The number of humid months varies between a maximum of 6 months at Kaduna in the south and a minimum of 4 months at Nguru in the east. *Figure 3.9* shows that the majority of the stations in the north recorded 4 wet months, while in the south stations the wet months were more than 6 months like Kaduna. Since the humid and arid months rely mainly on temperature and rainfall, and the elements of climate as discussed before under changing; temperature is increasing and rain is decreasing, which reflected on the distribution of wet and dry months in the study area over the study period, then this change threatens the agricultural activity in the study area from year to year. Rapid changes in this variability may severely disrupt the production systems and livelihoods (Desanker 2001).

#### **3.4.4 Aridity Index Trends in the Study Area (1946-2008)**

Due to De'Martonne aridity index, climate can be identified by the following types as: Aridity index:  $<5$  = arid climate; 5-10 = semi-arid climate; 10- $<20$  = sub-humid climate; over 20 = humid climate. Based on rainfall and temperature data (1946-2008), the arid index trends were computed at all the stations in the study. It can be deduced that the sub-humid climate prevails in northern parts, while humid climate prevails in the south of the study area. Because of increasing temperatures and decreasing precipitation, negative trends of the aridity index were computed at 50 per cent from the stations under study and the trend was very weak at Yelwa (*Table 3.6*, below). This behaviour of aridity trends indicates a growing aridity with time, which can accelerate desertification process in the north-western region of Nigeria.

The global climate models project that the mean annual surface temperature will rise by about 1.4–5.8°C by the year 2100 (IPCC 2001). Downscaling on regional scales, the confidence in future climate

3 Climate Change in Semi-Arid Region of Nigeria and Possible Impacts on Livelihoods

*El-Tantawi, A. M., Anming, B. and Ruma, M. M.*

**Figure 3.9:** Variation of Rainfall and Temperature According to Wet and Dry Months after Walter-Lieth, at Stations under Study (1946-2008)

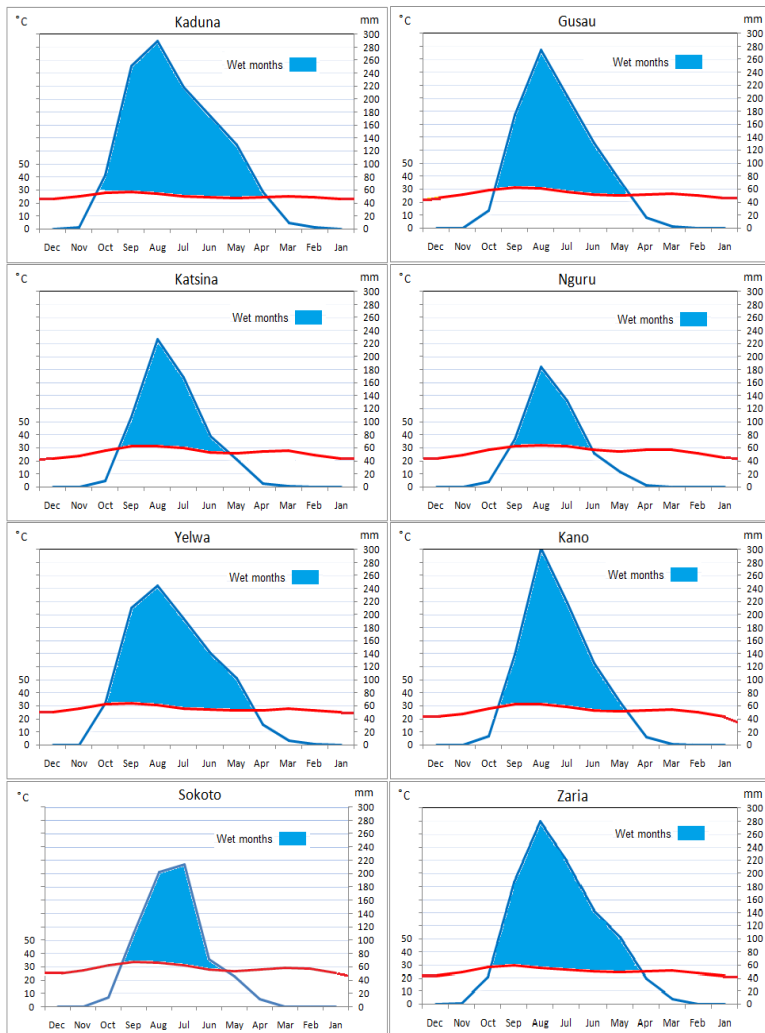

**Data source:** Nigerian Meteorological Agency, Abuja

**Table 3.6:** Aridity Index, Trends, and De'Martonne Climate Type (1946-2008)

Station	Aridity Index	Trend/Decade	De'Martonne Climate Type
Kano	24	1.24	Humid
Zaria	29	0.80	Humid
Katsina	16	-1.27	sub-humid
Kaduna	35	-1.14	Humid
Gusau	25	-0.78	Humid
Nguru	13	-1.32	sub-humid
Sokoto	16	1.41	sub-humid
Yelwa	26	0.10	Humid

**Data source:** Nigerian Meteorological Agency, Abuja

projections remains low. Besides, there is more confidence in temperature projections than in rainfall changes. By the end of this century, the global mean surface temperature is expected to increase by about 1.5-6 °C. The studies indicated that the temperature in Africa corresponds to global temperature and that the adverse impacts including extremes are spread across the diverse environments of Africa, putting a huge proportion of African continent at great risk (IPCC, 2003). Rainfall shows no uniform projections patterns over time and space; both increase and decrease were suggested.

Continued emissions of GHGs will cause further warming and changes in all the components of the climate system. Limiting climate change will require substantial and sustained reductions of GHGs emissions (IPCC 2013). It is expected that the change of climate in the study area will correspond to the global scenarios, as the changes in rainfall and

temperature over the study period (1946-2008) corresponded to the global change.

### **3.5 Possible Effects of Climate Change on Agriculture in the Study Area**

The climate affects agriculture and determines the adequacy of food supplies in two major ways; one is through weather hazards to crops, and the other is through the control exercised by climate on the type of agriculture feasible or viable in a given area (Ayoade 2004). Benson and Clay (1998) indicated that the 1980s were the driest decade throughout the 20<sup>th</sup> century, accompanied by drastic socio-economic implications like crop failure, famine, loss of livestock and epidemics. Also, seasonal or annual variations in the values of the climatic elements are of greater importance in determining the efficiency of crop growth (Ayoade 2004). The north-western region of Nigeria is characterised by semi-arid and tropical wet and dry climates which play a substantial role in agriculture. Under these limitations, the various drought factors produced specific chemical properties and soils which are naturally and characteristically fragile. Agriculture; livestock and fisheries are vulnerable to the impacts of climate change. The increase in temperature and frequency of extreme events will reduce crop yield, change of temperature will induce changes in the agricultural distribution of crops. Rainfall varies considerably on different timescales, which means the crop yields are very unpredictable. Shortage of rainfall will also force farmers to abandon marginal land and accelerates desertification.

As a result of the strong variability of rainfall in the study area, the cropped areas may appear to be under chronic agricultural water scarcity. Millet and maize production and yield in Katsina State experienced high variability from 1995 to 2006. *Table 3.7* (below)

shows the inter-annual variability of production and yield for both millet and maize crops from 1995 to 2006. The mean annual maize production was 196.01 metric tons in 1994/1995, while its production was 140.12, 176.21 and 155.44 metric tons in 2001/2002, 2002/2003, and 2005/2006 respectively (NBS 2007).

**Table 3.7:** Inter-annual Variability of Production (1000 Mt) and Yield (Kg/h) for Millet and Maize Crops in Katsina State from 1995 to 2006

Year	Millet Production	Millet Yield	Maize Production	Maize Yield
1995	1,297.83	743	0.969	969
1996	382.01	631	0.937	937
1997	312.37	755	1.006	1,006
1998	374.22	742	1.012	1,012
1999	349.41	1250	1.090	1,090
2000	158.78	718	0.831	831
2001	175.61	868	1.041	1,041
2002	169.59	868	1.041	1,041
2003	227.93	973	0.937	937
2004	199.77	907	1.072	1,072
2005	191.37	830	1.437	1,437
2006	206.36	904	1.102	1,102

**Source:** National Bureau of Statistics, 2007

As for yield, the yield of millet ranged between 937 kilogrammes per hour (kg/h) in 1996 and 1,437 kg/h 2005. It was noted also that six years from 10 years were below the average. Because of the large inter-annual variability of rainfall, this zone is subject to frequent dry spells, often

resulting in severe and widespread droughts capable of large-scale destruction of plants, animals and human life (Ati *et al.* 2009). Figure 3.10 shows that the production growth rate of corn, sorghum and millet

**Figure 3.10:** Production Growth Rate of Corn, Sorghum and Millet in Nigeria (1960-2014)

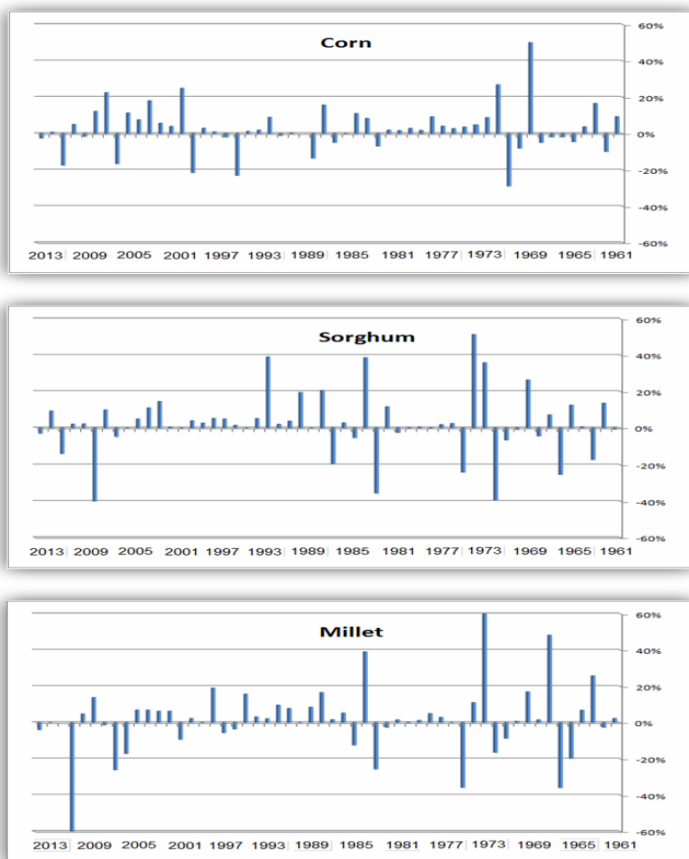

Data source: [www.indexmundi.com/agriculture](http://www.indexmundi.com/agriculture), 2015

in Nigeria (1960-2014) vary dramatically from year to year as a result of climate variability, especially rainfall. Vulnerability will increase and therefore the adaptation of farming systems is very important to agriculture crops.

Yield's variabilities of beans, maize and rice in Katsina State (1995-2006) have been investigated (*Figure 3.11*), the trends of the yields were positive but very weak and cannot cope with the population increase in the state. It was also noted that the variabilities were very high as the large inter-annual variability of rainfall. The correlations between the temperature and yield of maize and beans were medium positive, while it was very low negative between temperature and rice. For the correlation between rainfall and yields of beans and rice, they were low positive, while for maize, it was medium positive (*Table 3.8*).

**Figure 3.11:** Variabilities of Beans, Maize and Rice Yields (ton/h) in Katsina State, 1995-2006

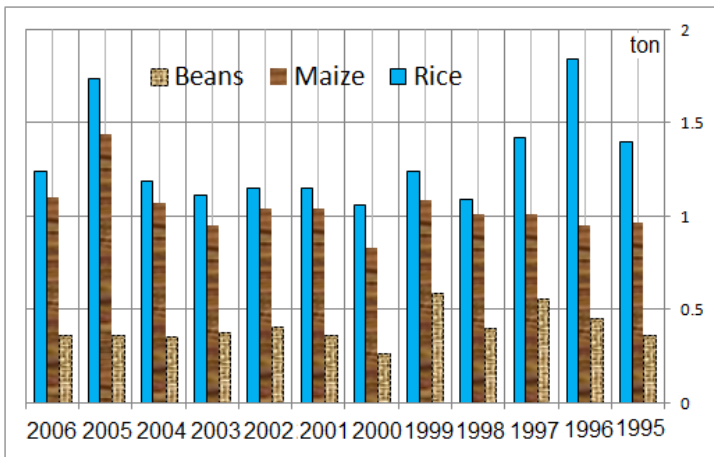

Source: National Bureau of Statistics, 2007

**Table 3.8:** Yields Trends (ton/h/decade) of Beans, Maize and Rice and Correlation with Rainfall and Temperature in Katsina State (1995-2006)

Crops	Trend/Decade	Corr./Rainfall	Corr./Temperature
Beans	0.09	0.14	0.31
Rice	0.15	0.14	-0.06
Maize	0.21	0.33	0.53

**Source:** National Bureau of Statistics, 2007

Yields variabilities of millet, groundnut and maize yields (ton/h) in Zamfara State (1995-2006) were investigated (*Figure 3.12*, below). The trends of the millet and maize yields were positive but very weak, while groundnut had no trend. It was also noted that the variabilities were very high as the large inter-annual variability of rainfall. The correlations between temperature, rainfall and yield of maize were negative but medium. For millet, the correlation was negative and medium with the temperature, while it was positive and low with rainfall. For correlation between rainfall and yield of groundnut, there was no correlation, while for temperature the correlation was positive and low (*Table 3.9*).

**Table 3.9:** Yields Trends (ton/h/decade) of Millet, Groundnut and Maize and Correlation with Rainfall and Temperature in Zamfara State (1995-2006)

Crops	Trend/Decade	Corr./Rainfall	Corr./Temperature
Millet	0.1	0.14	-0.32
Groundnut	00	00	0.24
Maize	0.1	-0.38	0.40

**Source:** National bureau of statistics, 2007



**Figure 3.12:** Variabilities of Millet, Groundnut and Maize Yields (ton/h) in Zamfara 1995-2006

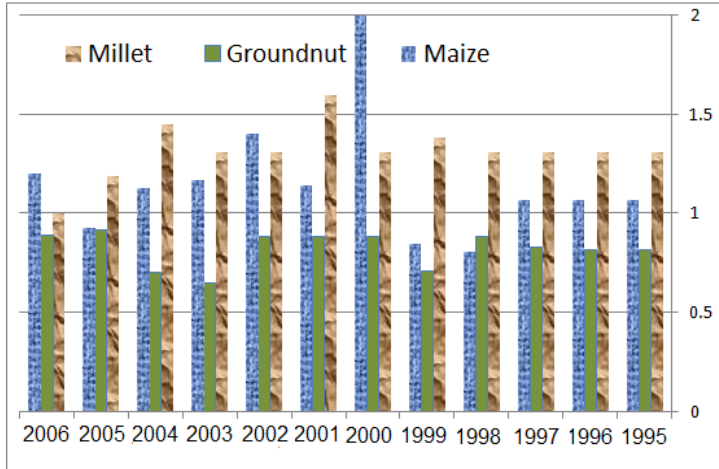

**Source:** National Bureau of Statistics, 2007

The distribution of total annual rainfall over time and space is clearly expressing the scarcity of water over most parts of the study area because the irrigated area is limited and most of the agricultural areas are cultivated under rain-fed conditions. An increase in rainfall variability can rapidly reduce agricultural productivity and alter the composition of grasslands.

Crops yields are affected by climatic variables, uneven rainfall distribution and prolonged arid period will lead to the further development of soil erosion and losses of fertile soil will increase (Schaefer 2001). Changes in the soil properties arising from climate change will have profound implications for agriculture given both the timescales and spatial coverage over which soil processes can operate

(Rounsevell *et al.* 1999). It can also be expected that climate change causes plant diseases; fungal diseases and insect pests such as locusts and aphids.

Climate change can also affect animal feed availability, livestock pastures and forage crop production and quality. Additionally, the weather and its extreme events have direct effects on animals' health, growth and production (Roetter and Vande 1999). As a result of rainfall variability and high temperature, the pastoral lands are inconstant in quantity and quality resulting in annual variability of animal numbers. Most of the pastoral lands are opened without any controls. That accelerates overgrazing followed by desertification. Future climate changes will greatly affect agriculture, but it is difficult to quantitatively assess the impact; for example, higher temperatures also enhance crop loss due to insect pests and weeds.

### **3.6 Conclusions**

Climate is considered one of the most limiting factors in human activities, especially, agriculture in recent decades, which indicate a growing magnitude of climate change. According to the analysis of temperature and precipitation data of the 8 stations scattered over the north-western region of Nigeria, it can be concluded that climate has generally become warmer and drier. Increasing trends of temperature prevail at all the stations corresponding to global change, rainfall declined in many areas over the study period and subjected to high inter-annual variability. But in general, all the trends of temperature and rainfall were not significant and not linear according to trend/noise ratios as the inter-annual variability was very high at all the stations. For the future, there is a general expectation of the continued warming trend and rainfall is expected to decrease and will become more uneven and variable over time and space in the study area.

The most prominent feature is the reduction in rainfall throughout the long-term period at most stations with negative trends observed from 1946 to 2008. While positive trends were observed from 1976 to 2008 at most stations, the trends were interrupted by multi-year anomalies over the study period. Variability of rainfall over northern Nigeria was more strikingly experienced from 1976 to 2008 than from 1946 to 2008 underlining a growing magnitude of climate change in the more recent time. Climate change in the study area affected the number of humid and arid months throughout the year seriously, which affected the growing season. It also affected the aridity index, especially, in the northern parts, which became drier as temperature increased, and rainfall decreased.

The changes in rainfall and temperature had significant impacts on rain-fed agriculture prevail in the study area. The relation between yields of some crops and rainfall and temperature show medium correlation and high variabilities of the yields. Climate change will also affect the scheduling of the cropping season as well as the duration of the growing season of each crop in the study area. Also, the effects of climate change can be noticed from the high variability of annual crop production change ratios in Nigeria. Vulnerability will increase and therefore the adaptation of farming systems is very important to agricultural crops. Understanding and quantifying climate change and anticipated impacts are becoming a matter of ever-increasing importance.

## References

- Almabruk, A. (1995): Reflections on Climate Variability within Selected Monthly Mean Time Series in Libya and Neighbouring Countries. *Geographia Polonica*. 65: 51-62.
- Ati, O. F., Stigter, C. J., Iguisi, E. O. & Afolayan, J. O. (2009): Profile of Rainfall Change and Variability in the Northern Nigeria, 1953-2002, *Research Journal of Environmental and Earth Sciences* 1(2): 58-63, Maxwell Scientific Organisation.
- Ayansina, A. and Odekunle, O. T. (2009): GIS Approach in Assessing Seasonal Rainfall Variability in Guinea Savanna Part of Nigeria, 7th FIG Regional Conference, Hanoi, Vietnam, 19-22 October 2009.
- Ayoade, J. O. (2004): Introduction to Climatology for the Tropics, 2nd edition, Spectrum Books Limited, Ibadan, Abuja, Lagos.
- Benson, C. and Clay, K. (1998): The Impact of Drought on Sub-Saharan African Economies. World Bank Technical Paper No. 401. Washington, D.C.
- Broms, B. (2004): Foundation Engineering. Geo Texts & Publications, Web forum Europe AB Legal disclaimer, [www.geoforum.com/knowledge/texts/broms/index.asp](http://www.geoforum.com/knowledge/texts/broms/index.asp)
- Desanker, P. V. (2001): Impact of Climate Change on Africa, [www.wwf.org.uk/file\\_library/pdf/Africa-climate-text.pdf](http://www.wwf.org.uk/file_library/pdf/Africa-climate-text.pdf).
- Domroes, M. (1996): Rainfall Variability Over Sri Lanka. In: P. A. Yash, Suloclana, G. and Govind, B. (eds.). *Climate Variability and Agriculture*, pp. 163-179. New Delhi: Narosa Publishing House.

- Domrös, M. and Peng, G. B. (1988): *Climate of China*. Heidelberg and New York: Springer Press.
- Donaire, J. (2000): *New Definitions of Climate and Climatic Change*, *Bull. Soc. Geog: Egypt*, Tome LXXIII, 73, Cairo, Egypt.
- El-Tantawi, A. (2011): *Recent Rainfall Variability in Northern Nigeria*. *Katsina Journal of Natural and Applied Sciences*. 2 (1) Feb. 2011: 52-73, Umaro Musa Yar'adua University- Katsina State, Nigeria.
- El-Tantawi, A. (2012): *The Effects of Climate on Human's Comfort and Health in North-western Region of Nigeria*, *Katsina Journal of Natural and Applied Sciences*, 3 (1) Sep. 2012, Umaro Musa Yar'adua University- Katsina State, Nigeria.
- El-Tantawi, A. (2013): *The Effects of Growing Season Variations on Food Crop Yields in Sokoto, North-Western Nigeria*, *Nigeria Geographical Journal*. 9 (1) (March 2013), Abuja, Nigeria.
- El-Tantawi, A. and Ibrahim, Y. (2011): *Towards a Comprehensive Approach of Addressing the Potential Impacts of Climate Change on Biodiversity in Northern Nigeria*, *Katsina Journal of Natural and Applied Sciences*, 2 (1) Feb. 2011: 100-120, Umaro Musa Yar'adua University- Katsina State, Nigeria.
- Obioha, Emeka, E. (2009): *Climate Variability, Environment Change and Food Security Nexus in Nigeria*. *Kamla-Raj 2009 Journal of Human Ecology*, 26(2): 107-121 (2009).
- FAO, (2014): *Statistical Year Book, Africa, Regional Office for Africa*, Accra. FAO., (2014): *Statistics Division*, <http://faostat3.fao.org/faostat-gateway/go/to>

- Folland, C. K. *et al.* (2001): Observed Climate Variability and Change. In: Houghton, J. T., Ding, Y., Griggs, D. J., Noguer, M., Linden, P. J., Dai, X., Maskell K. and Johnson C. A., (Eds.) (2001): *Climate Change: The Scientific Basis, Working Group I, Third Assessment Report, Intergovernmental Panel on Climate Change, UNEP and WMO.*
- Hess, T. M., William Stephens and Maryah, U. M. (1995): Rainfall trends in the North East Arid Zone of Nigeria, *Agricultural and Forest Meteorology* 74 (1995): 87-97. ELSEVIER.
- Intergovernmental Panel on Climate Change (IPCCa) (2001): *Climate Change 2001: The Scientific Basis, Summary for Policymakers. A report of working group I of the Intergovernmental Panel on Climate Change, <http://www.unep.ch/ipcc/pub/spm22-01.pdf> (2.4.2001)*
- (2001b): *Climate Change, Impacts, Adaptation and Vulnerability. "Working Group II". Intergovernmental Panel on Climate Change, 1-1 to Geneva: World Meteorological Organisation (WMO)/United Nations Environment Programme (UNEP).*
- (2007c): *Working Group II Contribution to the Intergovernmental Panel on Climate Change Fourth Assessment Report Climate Change 2007: Climate Change Impacts, Adaptation and Vulnerability.*
- (IPCC)(2013d): *Summary for Policymakers. In T. F. Stocker, D. Qin, G.-K. Plattner, M. Tignor, S.K. Allen, J. Boschung, A. Nauels, Y. Xia, V. Bex and P.M. Midgley (eds.) Climate Change (2013): The Physical Science Basis. A Contribution of Working Group I to the Fifth Assessment Report of the Intergovernmental Panel*

on Climate Change. The United Kingdom and New York, NY, USA: Cambridge University Press, Cambridge.

- (2014e): Climate Change 2014 Synthesis Report Summary for Policy Makers. [http://www.ipcc.ch/pdf/assessment-report/ar5/syr/AR5\\_SYR\\_FINAL\\_SPM.pdf](http://www.ipcc.ch/pdf/assessment-report/ar5/syr/AR5_SYR_FINAL_SPM.pdf) Retrieved on February 5<sup>th</sup>, 2018
- Jones, P. D., New, M., Paker, D. E., Martin, S. and Rigor, I. G. (1999): Surface Air Temperature and its Changes Over the Past 150 Years. *Reviews of Geophysics*. 37: 173-199. The American Geophysical Union.
- Kottek, M. J., Grieser, C., Beck, B. Rudolf and Rubel, F. (2010): World Map of Koeppen- Geiger Climate Classification Updated. [http://koeppen-geiger.vu-wien.ac.at/\(Stand: 2006- 04\) \(Zugriff: 2006-08-09\)](http://koeppen-geiger.vu-wien.ac.at/(Stand: 2006- 04) (Zugriff: 2006-08-09)
- Lockwood, J. (1974): World Climatology: ‘An Environmental Approach’. London: Edward Arnold.
- Macmillan (2006): Nigeria Secondary Atlas. Malaysia: Macmillan Publishers Limited.
- McCarthy, J. J., Canziani, O. F., Leary, N. A., Dokken, D. J. and White, K. S. (eds.) (2001): Third Assessment Report, Climate Change: Impacts, Adaptation and Vulnerability. IPCC, Working Group II, UNEP and WMO.
- National Bureau of Statistics (NBS) (2007): National Survey Report 1994/95-2005/06, Economic Reforms and Governance Project, Nigeria.

- Oguntoyinbo, J. S. (1983): *Climate and Mankind*. An inaugural lecture delivered on March 24, 1982, University of Ibadan, Nigeria.
- Olaniran, O. J. (2002): *Rainfall Anomalies in Nigeria: The Contemporary Understanding*. An inaugural lecture, University of Ilorin, Ilorin.
- Reuben, K. Udo (1981): *Geographical Regions of Nigeria*. London, Ibadan, and Nairobi: Heinemann Educational Books Limited.
- Ritter, M. (2003): *The Physical Environment: An Introduction to Physical Geography*,  
[http://www.uwsp.edu/geo/faculty/ritter/geog101/textbook/title\\_page.html](http://www.uwsp.edu/geo/faculty/ritter/geog101/textbook/title_page.html), 2.2.2005
- Roetter, R. and Van de Geijn, S. C. (1999): *Climate Change Effects on Plant Growth, Crop Yield and Livestock*. *Climatic Change* 43: 651-681 Amsterdam, Netherlands: Kluwer Academic Publishers.
- Rounsevell, M., Evans, S. and Bullock, P. (1999): *Climate Change and Agricultural Soils: Impacts and Adaptation*. *Climatic Change* 43: 683-709. Amsterdam, Netherlands: Kluwer Academic Publishers.
- Schaefer, D. (2001): *Recent Climate Change in China and Possible Impacts on Agriculture*. Conference on International Agricultural Research for Development, pp. 9-11, Bonn.
- Schoenwiese, C. (1992): *Praktische Statistik für Meteorologen und Geowissenschaftler*, 2. Verbesserte Auflage, Gebrüder Borntraeger, Berlin and Stuttgart.



- Sowunmi, F. A. and kintola, J. O. (2010): Effect of Climatic Variability on Maize Production in Nigeria. *Research Journal of Environmental and Earth Sciences* 2(1): 19-30, 2010, Maxwell Scientific Organization.
- Tarhule, A. A. (1997): Droughts, Rainfall and Rural Water Supply in Northern Nigeria. Open Dissertations and Theses. <http://digitalcommons.mcmaster.ca/opendissertations/1235>
- Thom, H. (1966): Some Methods of Climatological Analysis, World Metrological Organization (WMO) Technical Note 81, Geneva. [www.indexmundi.com/agriculture,2015](http://www.indexmundi.com/agriculture,2015)
- World Bank Group (WBG). Water and Climate. <http://water.worldbank.org/topics/water-resources-management/water-and-climate-change>. Retrieved on February 5<sup>th</sup>, 2018

## Chapter 4

### **Resource Depletion and Resource Conflict in the Lake Chad Basin: Issues and Solutions**

Onyekachukwu Nnaemezie Ugwu

Institute for Peace and Strategic Studies (IPSS)

University of Ibadan, Nigeria

Corresponding e-mail: ugwuonyeka3@gmail.com

#### **4.1 Introduction**

The antecedents have proven that there is an existing relationship between environmental resources, livelihood and conflicts. The interactions of these elements are not only indicative of inter or intrastate violent conflict generation but strongly critical to the survival and mainstay of residents, especially for their economic interests. Much more, the focus is often given to conflicts over hard resources of mineral and energy resources as can be alluded to conflicts such as the Congo civil war and the Persian Gulf crises. However, on the other hand, less attention is given to the study or assessment of conflicts deriving from the struggle over soft resources of water, soil produce and land (Onuoha 2008: 36).

Interestingly, this work considers this unpopular dimension of resource-based conflicts through the unravelling of conflict scenarios in the Lake Chad Basin (LCB). The LCB is a rich water resource, which straddles the borders of Nigeria, Niger, Cameroon and Chad but equally channels water to Central African Republic (CAR), Sudan, Libya and Algeria. It holds the strategic position as a source of economic livelihood to millions of people within its geospatial catchment (Onuoha 2008: 36; *Deutsche Gesellschaft für Internationale Zusammenarbeit* (German

Society for International Cooperation) [GIZ] n.d.: 63). However, the impact of climate change conditions has been detrimental to the water levels of the lake. Hence, low seasonal rainfalls have resulted in low tributaries causing a shortfall of water resources for residents, farmers, pastoralists and fishermen. (Hall 2009: 2). Much more, depletion, recession and contamination of the lake have led to the exacerbation of conflicts, some of which have degenerated into large-scale inter and intrastate conflicts, health hazards, migration, forced displacement and livelihood alternations and competitions over resources.

It is the purpose of this study to consider intrinsically these emerging developments in Lake Chad as well as answer the pertinent questions on the interactions between resource depletion and conflict instigations and escalations. The study also seeks to examine the implications of the depletion of water resources in the Lake Chad on contemporary humanitarian crises and will propose resolute responses from the humanitarian views that must be considered and consolidated to address the conflicts in the Lake Chad.

## **4.2 Conceptual Clarifications**

### **4.2.1 Resource Depletion**

According to Magdoff (2013), the concept of resource depletion is best captured as shortages, firstly, in the source of raw materials and natural resources, and secondly, as insufficiency of sinks to absorb wastes from industrial pollution, which are harmful to the environment. These shortages occur in the sources of raw materials such as fossil fuels, topsoil, freshwater and forest. In the production sector, these shortages are manifest in the depletion of resources of crude, mineral resources and freshwater resources. Magdoff further opined that when the earth exhausts a particular resource, it usually becomes economically unable

to resuscitate it. Hence, to maintain the availability of renewable resource like water, their usage should not exceed their rates of regeneration, but on the other hand, non-renewable resources like minerals can undergo the process of recycling as efficiently as possible.

Magdoff noted some of the distinct reasons for the depletion of resources. The first reason according to him can be attributed to the increasing exhaustion of the mineral resource-phosphate. He argued that the exhaustion of this mineral resource, which is efficient for nutrient recycling by the world's largest phosphate deposit countries of Morocco, US and China has made it more difficult to maintain food production. Hence, the wastage of phosphate has further contributed to the shedding of algae in lakes and rivers resulting in dead ocean zones.

His second reason for the resource problems facing the world is the unavailability of freshwater. The author emphasised that the exploitation of the aquifers in the US, Northern India and Northern China are root causes of shortfalls in water levels. Other reasons for resource depletion include global land grabs particularly for exploitation of biofuels. These land grabbing subsequently displace people from their traditional settlements forcing them to migrate to urban areas. The consequences are overpopulation, bump in food prices, hunger and environmental emissions, (Magdoff 2013: 13-14).

Bain (2007) argued that renewable resources as water, forest and soil are not sustainable and can easily be exploited to the point of exhaustion. To this end, he conceived depletion of natural resources as the reduction in the value of deposits of subsoil assets through physical removal or exhaustion. Put differently, renewable resources as forests, water and fish stocks can be depleted or used up as a result of harvesting, deforestation, erosion, respectively, among others. Bain

further argued that there is an inherent relationship between economic growth and depletion. Thus, he opined that other forms of depletion can include the reduction of mineral resources and shortfalls in the prices or value of economic resources. These also include changes in the quality of economic use, natural mortality of renewable resources, degradation through erosion, agricultural abuses and misuse, acid rain or excessive nutrient from soil surface runoffs. In addition, resource depletion can take the forms of catastrophe or natural disaster such as tsunami, wildfires, famine, drought, war and technological loses. (Bain 2007: 6-7).

On the other hand, Steer (2013: 3) argued that resources as water, forest and land exist within the market system. He argued that resource depletion has an effect on all the natural resources, which include marketed, non-marketed resources. Hence, Steer called on the need to “facilitate the provision of marketable resources such as timber and their regulations for soil creation, erosion control and climate regulation.”

#### **4.2.2 Resource Conflict**

The United States Institute for Peace (USIP) opined that conflict over resources is multidimensional and superfluously dynamic in patterns and operates from different conflict positions. This explains why over 50 per cent of conflict in 2001 had connections to resource issues. Popular resource conflicts include conflict over the oil fields in Kuwait, the Gulf War, Revolutionary United Front conflict over the ‘blood diamonds’ in Sierra Leone and struggle over the diamond mines by the National Union for the Total Independence of Angola (UNITA) (USIP 2007: 3). No doubt, the strategic importance of natural resources is integral to societies’ income, industry and identity. While some of these resources have import-export advantages, others exist in appreciating

values, as such, a multi-pronged demand for their possession suggests a potential for conflict. It has been postulated that conflict situations are not only the emerging outcomes of resource depletion but are also motivating factors for resource management and sustainable livelihood. This is a rather deteriorating outcome of resource conflict, which is characterised by rising tensions, shrinking of institutions and non-adherence to rules of resource use. The overt implication of this pattern of conflict is the total collapse of production systems, gross social conflict and insecurity.

In Africa, trans-boundary resources have been a source of complex conflict generation. For instance, the Kenya-Tanzania conflict over the Mara River basin and the competitions by nine countries; Egypt, Sudan, Tanzania, Kenya, Uganda, Burundi, Rwanda, Ethiopia and the Democratic Republic of Congo (DRC) over the Nile River have consistently created water insecurity. The compressing effect of this is the vulnerability to environmental crimes such as water pollution, piracy and resource overuse resulting from the increasing urban settlement. Environmental conflict surfaces when there is a connection between environmental degradation and activities of specific social agents. This multiplicity of events extends to social and economic dimensions. Thus, as Homer-Dixon law postulates, the effects of environmental scarcity such as constrained economic production, migration, social segmentation and a disrupted institution produce conflicts among groups, (Mwanika 2010: 3-4).

The UNEP argued that resource conflict is not unilaterally hinged on a struggle over one or a particular resource but can be a combination of more than one resource as a conflict driver. It submitted that resource conflict can manifest in four different dimensions;

- i. Conflict over resource ownership

- ii. Conflict over resource access
- iii. Conflict over decision-making over resource management
- iv. Conflict over the distribution of resource revenues, benefits and burdens (UNEP 2015: 14).

## **4.3 Theoretical Frameworks**

### **4.3.1 Resource Theory**

Resource theory is a multi-component concept. It is inferred that the way and manner resources are characterised is relatively tied to the understanding of their influence by consumer behaviour. This theory expounds that resources are characterised by three broad dimensions;

- i. personal (one's possessions, energies, knowledge), which can be in contrast with non-personal things such as environmental or contextual conditions,
- ii. economic and noneconomic assets, and
- iii. exchangeable and nonexchangeable resources such as personal traits.

One of the inherent contextual characteristics of resource theories is resource depletion, which explicates the decrease or decline of an expended resource. Such resources can be non-renewable or renewable. Another feature of resource theory is resource divisibility which explains the ability to partition resources into smaller units without losing the utility of the resource. This is intrinsically tied to the LCB Commission's mandate to regulate governance over the use of the lake by the four countries; Nigeria, Niger, Chad and Cameroun.

One of the structural conditions often posed by resource theory is the availability of resources (resource availability), which refers to the extent that resources can be obtained whenever it is needed. Hence,

resources can either be readily available (abundant) or unavailable (scarce). Theorists, however, submitted that the sufficiency or insufficiency of resources relatively determines preferences for the equity and equality of resource distribution. In the same vein, the availability or scarcity of one resource can considerably impact on other resources (Dorsch, Tornblom and Kazemi 2017: 3-4). In Lake Chad, the unavailability of water as a result of the continuous water recession invariably led to the unavailability of resources like fish, land for cultivation due to the increased salinity, among others.

#### **4.3.2 Malthusian Theory**

Theoretically, the concept of resource depletion is connected to the Malthusian Theory of environmental scarcity, which describes the availability of food as a direct consequence of population growth and conversely the shortages of other enabling environmental resource as a result of exponential population growth. Succinctly put, Thomas Malthus argued that exponential growth puts pressure on the resource as water, land and forest resulting in environmental scarcity and conflict. Furthermore, this growing population becomes suggestive triggers of violent conflict, forced migration and the shrinking capacity to ensure the provision of essential social security services.

#### **4.3.3 Neo-Malthusian Theory**

To understand vividly the role of natural resources (renewable or non-renewable resources) in conflict, it is salient to consider the Neo Malthusian Theory of Environmental Scarcity and Conflict. The Neo Malthusians argued that the combination of environmental degradation, resource depletion and unequal resources produce uncontrolled poverty outcomes, inequality, relative deprivation and frustration-aggression, which are catalysts for distillation of internal conflict, rebellion or



societal upheavals. This captures succinctly the crisis in Lake Chad, which has degenerated resulting in humanitarian interventions. This theory is linked with a thesis of the resource curse, which argued that scarcity is not the cause of conflict but resource abundance. Hence, the more the resource availability, the greater the chances of resource capture by corrupt regimes through violent conflict or looting, (USIP 2007:8-9).

#### **4.4 Methodology**

This study made use of a desk research technique relying on a range of existing resources from authoritative and valid secondary sources. These include books, journal articles online materials and institutional reports. The series of data used were extracted from the UN agencies (Food and Agriculture Organisation (FOA), United Nations Population Fund (UNFPA), United Nations Children's Fund (UNICEF), World Food Programme (WFP); reports from international Non-Governmental Organisations (NGOs) working in the Lake Chad and other various publications. Specific data extracted include environmental characteristics of the Lake Chad prior to and after climatic changes and effects (water distribution into the LCB countries, depletion of the basin, and conflict implications of resource depletion). While a content analysis of the collected data was conducted to determine the credibility of information used in this study, the eclectic use of secondary materials served to ensure the validity of this research and minimise the risk of error. This study however made use of statistical data in the form of tables and charts as empirical evidence.

## **4.5 Results and Discussions**

### **4.5.1 Geopolitical Features of the Lake Chad Basin**

The LCB is located as a former inland sea believed to have shrunken over the years due to the changes in climatic conditions. The LCB exists as one of Africa's largest lakes that provides freshwater for over 45 million people in the countries, Cameroon, Niger, Nigeria and Chad, surrounding it.

In terms of distribution outflow, the lake channels water to Chad (42 per cent), Niger (28 per cent), Nigeria (21 per cent) and Cameroon (9 per cent). The Chad Basin is drained by tributary rivers, which include the Chari-logone, Komadugu-Gana (Lesser Yobe Ebeji), Ebeji Mbuli, Botha El Beed, the Yedseran, Ngadolu, Ngadda, Komadagu-Yobe, Taftaf and Serbewel (Onuoha 2008: 43-44). By 1960, it was recorded that the Lake Chad was the fourth largest lake in Africa and second largest endorheic lake in the world. By 1950, it covered over 37,000 km, by 1960, the lake managed to cover 26,000 km and but by the mid-1990s, it has further depleted to cover 15,000 km. By the turn of the millennium, the lake lost about 96 per cent of its waters, shrinking to about 1,350 km<sup>2</sup>. In fact, in Nigeria, the lake has completely receded beyond its border (Onuoha 2008: 43-44).

The lake is fed by the northern and southern pools, which constitute water depth of three to seven feet. The shallow depth of the lake has subjected it to certain fluctuations, which have been common throughout history due to the properties of the lake. It is posited that water has been receding since 1400 but this has largely gone unreported. Thus, most of the depictions of the lake on the map from the 1960s are only casual observations of the high-water mark (Hall 2009: 26).

**Figure 4.1:** Geopolitical Configuration of the Lake Chad Basin

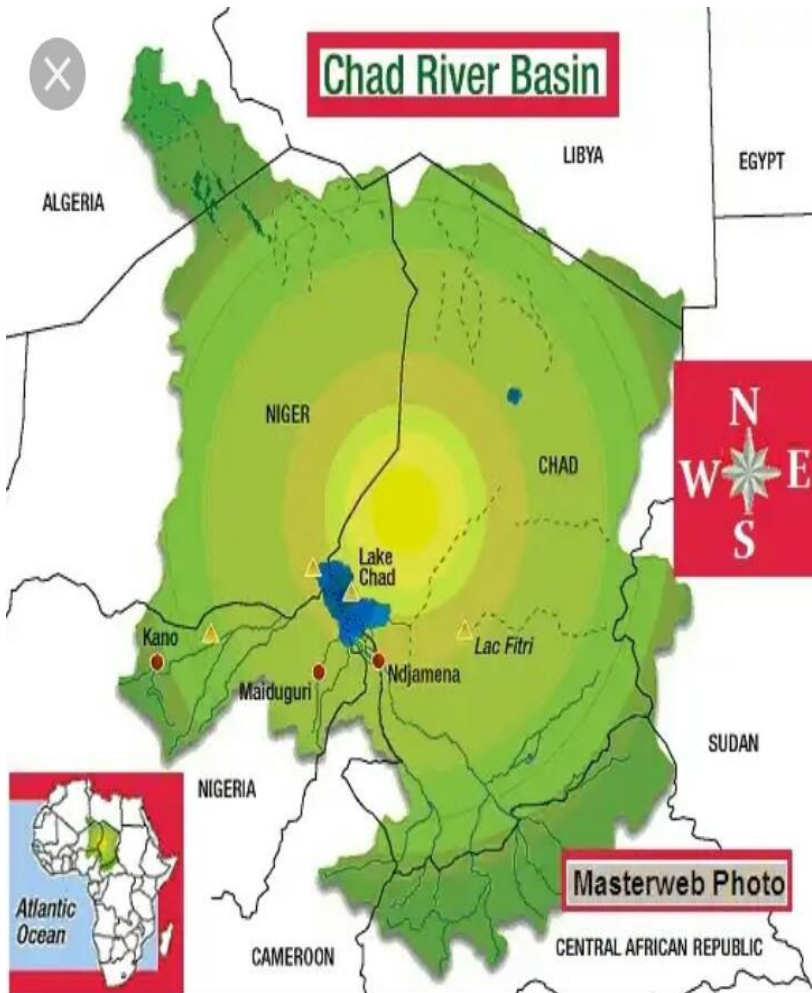

Source: Masterweb Photo, 2016

**Chart 4.1:** Water Distribution Outflow

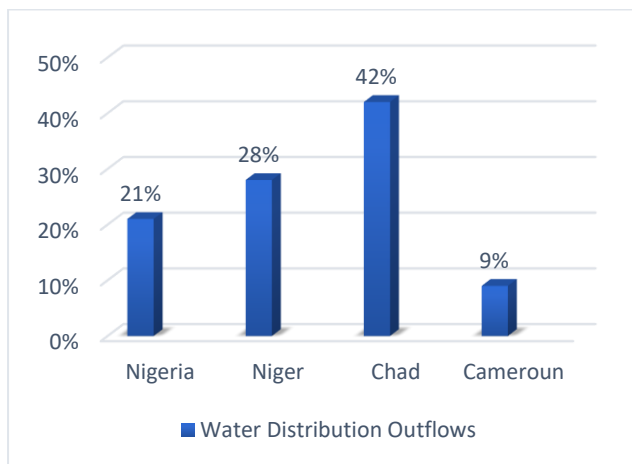

Source: Onuoha, 2008

**Chart 4.2:** Depletion of the Lake Chad in Km (1950-2010)

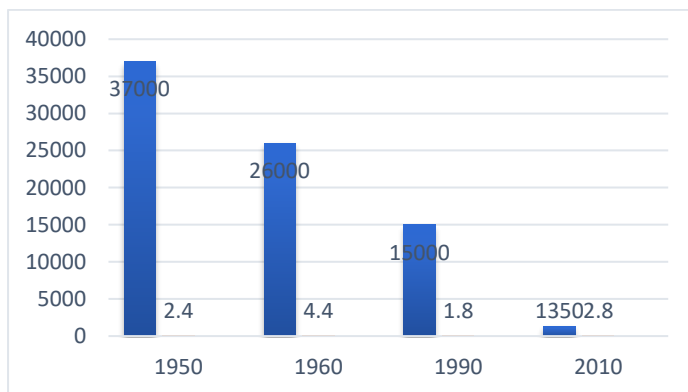

Source: Onuoha, 2008

The UN Convention, however, specified the equitability of water resources among states. Hence, there should exist water agreements and governance over the use of the lake and its tributaries. However, only one agreement exists between Nigeria and the Niger Republic. The water agreement specified the sharing of water catchments such as rivers, pools, tributaries, streams and aquifers. The largest water catchment is the Komadugu-Yobe river, which provides a potential flow of 1,296 million m<sup>3</sup> of water but the actual flow that makes it to the LCB is less than 2 per cent. The Maggia-Lamido and Gada-Gulbin Maradi catchments are the second and third largest catchments of water bodies respectively, which provide a potential flow of 292 million m<sup>3</sup>. It is, however, argued that while these two countries have an agreement on water use, water distribution is not equal. For instance, only about 150,000 Nigeriens have access to perennial rainfall while nearly two million Nigerians have access to seasonal rainfall and as such are prone to severe drought conditions (Hall 2009: 24-25).

Niasse (2005: 5) noted that the configuration of West Africa as a wet and arid zone explains why the Lake Chad Basin is a region with evidence of high and short rainfalls simultaneously. The Lake Chad Basin Commission (LCBC) was formed in 1964 as a move to provide governance in the management of water resources and maintain peace and security in the LCB. Though the four riparian states; Cameroun, Chad Republic, Niger and Nigeria conceived LCBC, it was later expanded to include the CAR (in 1996), Sudan as an observer state (in 2000) and Libya (in 2008). Other observer states include Egypt, Congo Brazzaville and the DRC.

By the 1960s, Africa was hit by a toll of climatic changes making the continent vulnerable to climate change and climate variability. Since then, drought has continually resulted in devastating local agriculture

and heightened famine. The slight increases in temperature have also changed the ecological landscape of Africa, including the LCB. What this means is that the reduction and recession of water in the lake, as well as the unpredictability of rainfall, have proven disadvantageous to the LCB. The experience of water stress in Lake Chad together with the confluence of population growth and migration create severe conditions for the lake (Hall 2009: 22). For instance, from 1973 to 74 and 1983 to 84, the Sahelian droughts critically affected the ecosystem of the lake while there was gross desertification in the Sahara region and the changes in the ecosystems affected the rainfall upon which the Lake Chad depends.

**Table 4.1:** Socio-economic Characteristics of Selected Countries Around the Lake Chad Basin

Factors	Nigeria	Niger	Chad	Cameroun
Total Population	195,642,762	19,245,344	15,332,002	24,649,147
Population Density per km	212.04	16.3	11.96	51.91
Population Growth Rate	2.61%	3.19%	1.86%	2.60%
GDP Growth Rate	1.9%	5%	3.3%	4.10%
HDI Estimates	0.527 (152 out of 188)	0.353 (187)	0.396 (186)	0.518 (151)

**Source:** World Atlas, 2017

#### 4.5.2 Population Profile of the Lake Chad Basin Countries

Four countries; Cameroun, Chad, Niger and Nigeria, surround the LCB. The countries constitute an estimated 246 million people according to the 2017 population estimate. While Nigeria with a population estimate of 186 million accounts for 75 per cent, Cameroun, Niger and Chad account for 10 per cent, eight per cent and six per cent of the population respectively. The sub-region's population growth rate, however, is still one of the world's largest accounting for an average 2.8 per cent despite the significant differences among the four countries. Thus, Cameroon (2.5 per cent per year) and Nigeria (2.7 per cent per year) with Chad and Niger (at 3.3 per cent and 4 per cent respectively) recorded the highest population growth rate in 2017 (UNFPA 2017: 16-17).

It is estimated that the four countries around the LCB are expected to double their population in an average period of 25 years. While Cameroun will double by 28 years, Nigeria will double in 26 years' time, Chad in 21 years and Niger in 17 years (UNFPA 2017: 16).

**Chart 4.3:** Estimated Population of the Lake Chad Basin

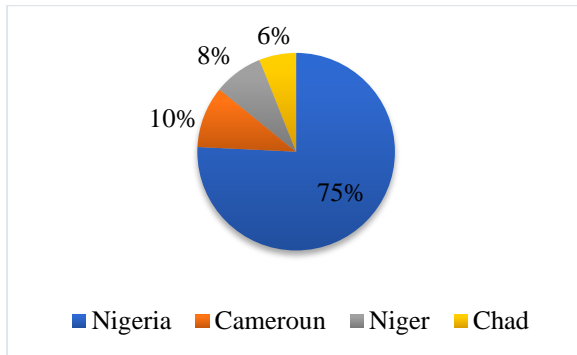

Source: UNFPA, 2017

**Chart 4.4:** Estimated Population Growth in the Lake Chad Basin

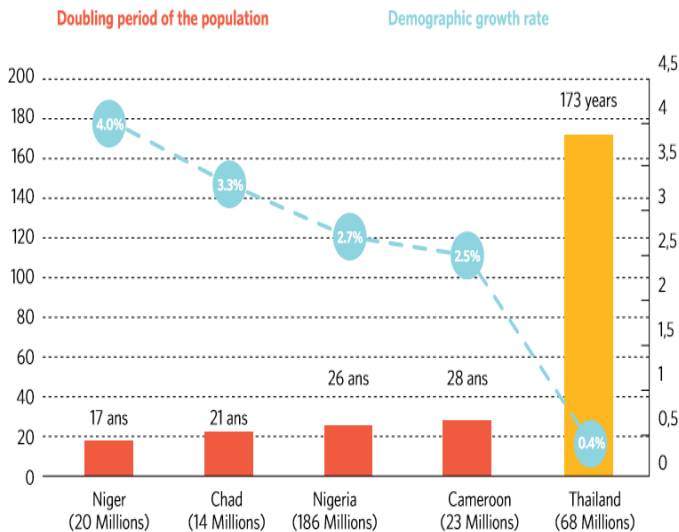

**Source:** UNFPA-WCARO Regional Office for West and Central Africa, 2017

With this current growth rate in the LCB, it is highly predictable that the population would increase by 74 million by the turn of 2034, a number which does not consider the influx of refugees that could enter the region in the coming years (UNFPA 2017: 17).

The human settlement in the LCB consists of different groups with different cultures, religion, language and economic activities. In Chad, the Saras are popular for farming, while the Budumas engage in fishing, the Arabs are herders and the Masas are sedentary livestock farmers. In Cameroun, the Fula are dominant in population dwelling mostly in the northern tip, which is also settled by the Saras, Masas, Arabs and Kotoko. In Nigeria and Niger, settlers are dominantly Hausa and Fula



(Fulani and Fulbe) (GIZ: 61).

#### **4.5.3 Environmental Resources in the Lake Chad and Their Socio-economic Advantages**

The Lake Chad is a prime source of freshwater for economic sources of livelihood such as fishing, pastoralism and farming. At the height of the lake's supplies, it is claimed that over 150,000 fishermen took advantage of the lake and its islands due to the peak production in fishing which saw to an annual harvest of 130,000-140,000 tonnes of fishes between 1960-1970.

Similarly, the lake is an additional source of livelihood for nomadic herders and pastoralists particularly in Tuareg, Toubon, Feda, Kanembu, Shuwa Fulani and Wadai from Chad, Nigeria, Northern Cameroon and Northern Nigeria providing fresh foliage for cattle and other grazing animals. Within its optimum period, the lake was a table source for freshwater for drinking, sanitation and even irrigation supporting the production of crops such as sorghum, groundnut, cassava, maize, rice and onions (Onuoha 2008: 45-49). Freshwater was a vital source from the lake, which played strategic socioeconomic roles for livelihood generation, support and sustenance. The lake is also strategic in annual water supply and flood control.

Despite these advantages, the lake witnessed a downturn in its water resource from the 1970s. Within this period, the lake shrunk as a result of complicated human activities and the force of climate change conditions. The conditions include shortage of rainfalls, drier climate, disappearance of the vegetation that supported grazing of livestock as a result of overdependence of farmers and fishermen on the lake as a source of water and livelihood. The conditions further include the burden stress of livestock and population stress on the lake as its source

Figure 4.2: Lake Chad's Contribution to Food Security in the Region

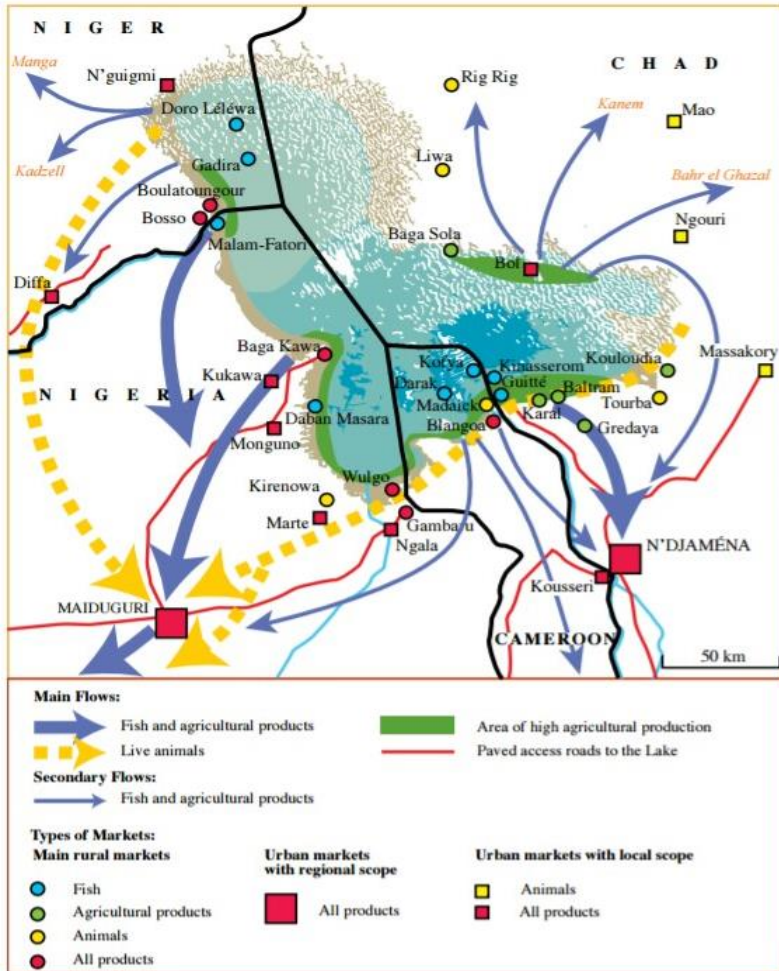

Source: Magrin, Lemoalle, Pourtier, 2015. Atlas du Lac Tchad

of water, agricultural practices and fishing livelihood. The interruption of economic livelihood produced a 'conflict of competition' among the various livelihoods over the limited water resources, and as well, increased migration within the basin. These migrations were basically economically motivated as farmers and pastoralists engaged in a contentious search for alternative sources. In the same vein, the surge in population from 1970 within the basin served to be a nexus of the scarce water resource depletion, population increase [the 'population bomb'] and migration patterns (Onuoha 2008: 50-51).

It is instructive to note that the reterritorialisation of borders by countries in the LCB further entrenched conflict over resources within the basin. This was because conflicts over these resources assumed a violent conflict position when they were contested beyond the territorial border. Hence, just as Onuoha (2008) captured, the source of the conflicts in the LCB manifested in two forms; conflicts of ownership and conflicts of use. Further expounding on these conflict dimensions, Onuoha argued that conflict over ownership involved parties from different nationalities, which can be interstate in dimension. An instance of this conflict form was the 1980s factional conflict between the Nigerian, Chadian and Cameroonian fishermen. The heated conflict resulted in the loss of nine Nigerians, 75 Chadian troops and the capture of 26 Nigerians and 32 Chadians (Onuoha 2008: 52-53).

The second form of conflict, conflict over use, relates to how the use of resources of the basin affects the livelihood of other users. Here, the focus is on the access to water for production and livelihood sustenance.

Other misgivings of the depletion of the LCB is the deterioration of the irrigation, which has in like manner reduced the quality and quantity of water. The resulting effect is a livelihood switch from fishing to

farming, migration and eventual contentions between pastoralists, fishermen and farmers (Onuoha 2008: 53).

#### **4.5.4 Conflict Implications of Resource Depletion in the Lake Chad Basin and Beyond**

##### **i. Competition for Scarce Water Resources**

One of the principal reasons for the depletion of water resources in the LCB is hinged on climate change or climate fluctuation, which is responsible for the drying up of the lake. These short-term, long-term and seasonal fluctuations are responsible for the overt climatic changes. The significant decrease in the water resource availability in LCB is largely attributable to the combined impact of climate change and the increased water withdrawals including the multiplication of construction of large dams as well as water overdependency by the overpopulated residents, which in turn exacerbate conflict in the region. For instance, the Komadugu Yobe River system has experienced severe impacts of climate change between 1972 and 1992; the Tiga and Challewa Dams were used to diverting substantial water flow for domestic use and migration, thus there was a 30 per cent decline of the lake from 1960 to 1969 and 26 per cent decline from 1970 to 1979. By the 2000s, the lake reduced to span only 1,350 km. This situation has further degenerated to water warfare among farmers who strive to survive by digging channels in order to divert as much water as possible into their farms (Niasse 2005: 6).

In the north-eastern Nigeria, which consists of Adamawa, Bauchi, Borno, Gombe, Taraba and Yobe with an estimated population of 20 million people in the LCB, the increased water security challenges compounded competition between users and their demands. Secondly, the hygiene and health of the population were put at risk. The needs for

access to safe drinking water and water for sanitation were primarily the causes of the competition over the scarce water resource, leading to the deterioration of water quality and the emergence of water-related diseases on the residents of the region, (Onuoha 2000: 54).

## **ii. Food Insecurity**

Another implication of resource depletion in the LCB is the shrinking of the lake, which poses a long-lasting threat to food security as well as an exacerbation of poverty and malnutrition in the region. It is instructive to note that the region (north-eastern Nigeria) has already been strained through a number of coping mechanisms as it accommodates the highest poverty rates population; in Nigeria (72.2 per cent) while the LCB region is one of the poorest regions in the world. Hence, the vulnerability of Lake Chad to water security concomitantly means chronic food insecurity as a result of crop failures, livestock and fishes' deaths, soil salinity, disruption of economic livelihood and mass displacement in search of better livelihoods (Onuoha 2008: 55).

A WFP Report (2017) reported an alarming malnutrition rate, 18.1 per cent, in the region while it estimated that 1.4 million people will be food insecure in 2018. According to the FAO (2017) strategic response guide, it argued that about 66 per cent (from 49.5 per cent in October 2016) of the displaced people that participated in a survey in camps and host communities in Nigeria in December 2016 noted food as their biggest unmet need. For the fact that agriculture is the primary source of livelihood for many of the internally displaced people (IDPs) in the period before their displacement, it is imperative to create accessibility to land, which will help farmers grow food crops, raise livestock and engage in other livelihood activities. (FAO 2017: 3). To address this, the humanitarian responses to tackling the food insecurity has been

diverse but country context specific. In Nigeria, the WFP through the Emergency Food Security Assessment (EPSA) postulated that food insecurity rate in Borno State alone was 10 per cent. However, through interventions such as the Cash-Based Transfer (CBT) among IDPs between March and October 2017, food insecurity declined from 26 per cent to 9 per cent while 1.16 million benefitted from this programme in Adamawa, Borno and Yobe. In Cameroon, over 300,000 beneficiaries were assisted in 2017 (WFP November 2017: 2).

### **iii. Infant and Maternal Mortality**

The LCB countries also suffer from high infant mortality rates due to poor public health conditions. The CAR, for example, has an alarming rate of nearly 100 infant deaths per 1,000 live births, followed closely by Chad and Nigeria. Libya has a markedly lower infant mortality rate, at 15.4 infant deaths per 1,000 live births, a fertility index of only 2.67 children per woman and a life expectancy of 74 years. This has decreased life expectancy in countries like CAR, where life expectancy at birth is low (for example, 48.5 years and around 58 years in Niger) while life expectancy in Cameroon in 2012 was the same as it was in 1990 (GIZ: 69).

Also, in the LCB, maternal mortality is rapid. That is as a result of various causal factors, which include human right abuses, rape, loss of life due to lack of skilled birth attendants, unavailability or inaccessibility of family planning services, malnutrition and female recruitment into terrorism. While maternal mortality rate in the significantly stable African countries stands at 97.2 out of every 100,000 live births, in the protracted African countries it is 556.7 out of every 100,000 live births and the maternal mortality rate in the LCB stands at 773.4 for every 100,000 live births (GIZ: 69).

**Chart 4.5:** Maternal Mortality and Birth Rates

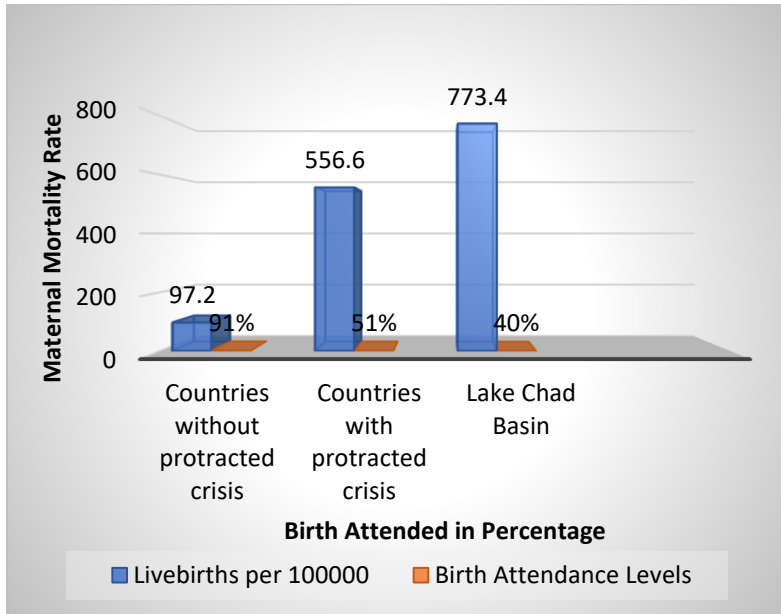

#### **iv. Forced Migration**

Forced migration is another consequence of the depletion of the water resource. The droughts of 1973 and 1984 and again in 2008 prompted a large-scale migration of herders and their cattle towards the wetlands' regions around Lake Chad and sometimes further south. These climatic impacts on the population increased pressure on the resources of the lake and led to conflicts over water sources. The variability of the water level of the lake prompted fishermen from the northern regions to move to the southern areas and has also seen to the development of new villages on lakeside areas, both along its shore and on the drained land,

which was revealed as waters retreated. Thus, the fishermen moved with the waters as it continually receded.

Furthermore, many pastoralists have headed south, moving particularly into the neighbouring Oubangi River Basin in search of pasture and water. And that has overtime created social tensions and security problems between newcomers and the indigenous communities. Other consequences of forced migration include the wars in Darfur and South Sudan in the 2000s, which prompted mass movements of people into Chad and the CAR. A peculiar impact of forced migration is the direct impact it has on the availability and use of scarce resources in the host regions, a situation which heightens tensions among the local population, leading to conflict.

#### **v. Strained Livelihood Opportunities**

Tensions are not just rising due to population growth and the ongoing exploitation of forests for fuelwood, but also due to the fact that the nomadic communities increasingly move southwards as their previously fertile grazing lands become depleted. Extensive transhumant livestock production equally faces a range of obstacles, particularly the pressure in certain areas to grow crops in transhumance corridors. At the local level, the increasing incursion of crops growing into rangelands is traditionally dedicated solely to extensive livestock production as conflicts between livestock farmers and crop farmers are a recurrent issue.

For the fishermen, climate change has had a profound influence on fishing in the LCB. Hence, for 40 years, Lake Chad's northern pool remained dewatered for a long period (1976–2016), forcing fishermen to diversify their activities and move into farming, due to the uncertainty and insecurity caused by the varying water levels of the



lake. The species of fish currently caught by fishermen, although once plentiful and varied, struggle to survive the onslaught of overfishing and the drop in water levels caused by the variability of the climate (GIZ n. d.: 105-106).

On the other hand, the initiation of development policies implemented in the LCB countries to meet the Millennium Development Goals (MDGs) were not enough to effectively combat poverty as enough revenue per capita income were poorly distributed among the teeming residents. In fact, by 2012, the poverty rate in the LCB stood at very high figures. In Nigeria at 68 per cent, CAR at 62.8 per cent, Chad at 61.9 per cent), Niger at 46.8 per cent), Cameroon at 9.6 per cent (GIZ n.d.: 76-77).

#### **vi. Health Insecurity**

Water depletion has resulted in contamination of the water bodies further leading to waterborne diseases primarily caused when people drink water contaminated with human or animal faeces. Such diseases include cholera, typhoid, dysentery and diarrhoea, they become the order of the day. In Lake Chad, children and pregnant women are the most vulnerable to waterborne infections such as diarrhoeal diseases, which are the main causes of child mortality. In the same vein, diseases spread by water-related vectors are also very common. They include malaria, yellow fever, dengue fever, filariasis (e.g. elephantiasis and river blindness) and trypanosomiasis. Bouts of malaria, known locally as the 'fever', are responsible for many deaths among young children. Around 50 per cent of the diagnoses recorded in health clinics is for malaria. In 2015, Chad reported 41 per cent guinea worm disease cases spread through exposure to drinkable water contaminated with worms' larvae. Other causes of mortality and morbidity in Chad include poor levels of sanitation and hygiene among its population. (GIZ: 110).

Worse still, the emergent outbreaks of diseases such as pneumonia, watery diarrhoea and hepatitis E were prevalent in 2017. Hence, from May to the end of 2017, over 420 cases of hepatitis E were recorded in three Local Government Areas (LGAs) in Borno State and this has been in increasing statistics especially in Ngala LGA. There were also 25 cases of hepatitis E outbreak in Rann, summing up to 2,035 cases of hepatitis E recorded in Diffa (Niger) between 2nd January and 24th October. In Borno, there were 5,336 cases of cholera, which were recorded in 2017 (ACF and DRC 2017).

#### **vii. Malnutrition**

The somewhat recurrent epidemics, droughts, floods and ongoing climate change-related problems in the LCB have been worsened by the Boko Haram conflict and concomitant displacements. Put differently, violence, insecurity and resulting massive displacement of people across north-east Nigeria, Chad, Cameroon and Niger have exacerbated an already delicate nutrition situation. The severe acute malnutrition in north-east Nigeria has meant that children in areas affected had to face a high prevalence of severe acute malnutrition. A total of 10.9 million people are in need of emergency aid, of which 7.1 million people are severely food insecure, while in a recent report by UNICEF in 2016, 515,000 children under five years are suffering from severe acute malnutrition, 450,000 in north-east Nigeria alone, a figure which is postulated to increase beyond that (UNICEF ACF and DRC 2017).

#### **viii. Conflicts and Displacements**

The LCB is not new to conflicts. In 1983, as a result of the influx of refugees flowing into Nigeria, Nigeria and Chadian military engaged in a conflict over the territorial dispute, a conflict that led to 100 casualties. As a result, Nigeria closed its border until 1986. In 1987, the Nigerian fishermen who migrated to Cameroon in the Darak village in pursuit of

the Lake Chad posed a threat to the Cameroonian fishermen in a water dispute. By the mid-1990s, over 30 villages were established and occupied by the Nigerian fishermen. The resulting effect of this skirmish was the deployment of the armed forces (military and police) to ensure a consolidated establishment of Nigerian schools, health centres and integration of Darak, Ramin, Naira and Drinna villages as part of the Nigerian District of Walgo in Ngala LGA of Borno State.

It is estimated, that between 1960 and 1994, over 60,000 Nigerians followed the receding waters and invariably cultivating and fishing on the Cameroonian territorial borders. The Nigerian government through the Borno State government administered governance and control over these villages; levied taxes, provided essential services such as police surveillance, official census, appointment of village leaders (bulama), establishment of public-school systems, medical support, establishment of fishing regulations and licensing of fishermen. While the Nigerian state considered the occupants as Nigerian citizens dwelling in Nigerian territories, the Cameroonian government considered this an act of invasion on their territorial space and violation of international treaty on respect for territorial integrity. After unsuccessful attempts to quell the crises by the military, the court of Arbitration at the International Court of Justice ruled in favour of Cameroon (Niasse 2005: 10-13). While the Cameroonian government recognised the Thomson-Marchland Treaty of 1929, which delineated a tri-border point among Chad, Nigeria and Cameroun. The Nigerian government argued that the demarcation of the borders was preliminary and not binding and that the demarcation of the border was the responsibility of the LCBC, which had not been accepted by all the four states. Since the states' borders were unclear, Nigeria asserted sovereignty, not on the argument of territory; rather on Cameroon's acquiesce of Nigeria's expansion.

This conflict was, however, settled by the International Court of Justice, which gave a decision after eight years in the favour of Cameroun (Hall 2009: 35-36).

On the other hand, the displacement in the LCB has been conceived to be a traditional norm as borders served as exchange points for economic and educational purposes. Thus, it was popular for farmers to move their families and herds to settle across their borders for the purpose of agriculture or pastoralism. Education-wise, universities such as the University of Maiduguri and the Usman Dan Fodio University of Sokoto both of Nigeria, were sub-regional academic hotspots for the students from the four countries.

Conflicts in the LCB along the borders of Nigeria, Niger, Chad and Cameroon has intensified in recent years with the terrorist activities of Boko Haram. Hence, humanitarian crises have grown from not just for a quest for scarce resources, but also an escape from conflict and violent extremism. With the current dynamics of conflict and terrorism in the region, the Lake Chad has turned to be a basin for crises, witnessing over 2.5 million internal displacements, refugees and returnees, making it the second largest scourge area in the world behind Syria. The intensity of this scourge between 2015 and 2017 is such that it is estimated that 92.9 per cent have been displaced because of the insurgency, 5.5 per cent due to community clashes, particularly between herders and native farmers, mainly in Nigeria, and 1.5 per cent because of natural disasters, mainly in Cameroon's far north, which experiences periodic flooding (FAO 2017: 2). By 2016, the LCB became the largest Africa's displacement's hubs as over 2.6 million people either escaped from the Boko Haram insurgents or the counterinsurgency forces. Out of this mass figure includes 1.9 million Nigerians, 427,000 displaced in Niger, Chad and Cameroon, and

155,000 Nigerians displaced in these countries. The burden of the displaced millions of people on the host communities is argued to have worsened the socio-economic and socio-political conditions of the region as water scarcity, hunger and limited livelihood opportunities continue to deride the basin. This increasing pressure on the limited resources, in turn, leads to greater competition over basic services (Oxfam 2016: 2-3).

**Table 4.2:** Number of Displaced Persons

<b>Countries</b>	<b>Number of Displaced (as of 2017)</b>
Nigeria	1,900,000
Cameroun	251,000
Niger	226,000
Chad	112,400

Much more is the gross insecurity that is posed to the returnees, with clear indicators such as the presence of the Boko Haram insurgents, the presence of multiple improvised explosive devices (IEDs), military operations and activities, destroyed infrastructure and price fluctuations. As of December 2016, it was estimated that there have been about one million returnees in the affected regions of the Lake Chad region (FAO 2017: 3). A report from the Action Against Hunger (ACF) and Danish Refugee Council (DRC) (2017) captured the above argument succinctly, thus, “most of the displaced people rely on the scarce resources of host communities, who have also lost their productive assets, reducing their own incomes and resulting in food shortages.” At exhaustion, the displaced begin to take up risky ventures

such as hawking, begging, child labour and transactional sex to satisfy their needs. Another implication of these displacements is that among the displaced population are the farmers and pastoralists who constitute significantly the livelihood producers and labour force. However, since they are equally displaced and are food insecure, consumers who are reliant on local markets for foodstuffs are adversely affected (ACF and DRC 2017).

#### **4.6 Conclusion**

This study has succeeded in establishing the intricate linkages that exist between environmental resource depletion of the LCB and resource conflict, which hinge firmly on water security and resource challenges as an emergent outcome. This often results in the disruption of natural activities, duplicates scarcity in the form of food insecurity and health security, initiates alternative livelihood, a catalyst for competition, migration and displacements. This study concludes by making a trumpeted call for immediate response strategies to go beyond initiation to activated implementation through a combined effort from institutional and political processes and regulations to ensure the mitigation of crises and management of the LCB.

#### **4.7 Recommendations**

In view of the findings of the study, the following suggestions would be relevant to tackle resource depletion and conflict in the LCB:

The LCB crises require a well-coordinated and transparent governance of the humanitarian crises within the region. It is important that the food security programmes and initiatives be carried out through combined technical operations by experts such as the FOA and the Office for Coordination of Humanitarian Affairs (OCHA) both of the UN. In the same effort, nutrition analysis can be carried out by expert organisations

such as the Permanent Inter-State Committee for Drought Control in the Sahel (CILSS), WFP, governments and NGOs.

It is important to scale up funding programmes for the LCB rehabilitation and reintegration. This will, extensively, capture the basic services on early recovery, short-term (1-3 months), mid-term (4-6 months) and long-term (7 months - 1 year or beyond) development programmes. In the same vein, to facilitate the resilience of the local population, funding should not only be depended on and as well not from the donor agencies alone. Thus, the high dependency syndrome should be controlled and the focus shifted more on tackling the interconnecting root causes of the LCB crises and the provision of long-term support and solutions to the basic needs of livelihood and shelter (ACF and DRC 2017).

It is imperative to explore water management options to ensure a sustained inflow of water into Lake Chad. Experts have suggested that water management strategies can either be in two major forms:

Firstly, the supply management (development of marginal water sources, groundwater exploitation, reducing the demand on the Lake Chad through conservation and increased water use efficiency, treatment and reuse of wastewater for irrigation, desalination of brackish water, soil water management).

Secondly, it can also be achieved through adaptive strategies, which include the use of advanced technology and water saving devices. It is posited that when this environmental quality and water resource objectives are prioritised, it would improve the quality and quantity of water, conservation of biodiversity of resources in the LCB, restoration and preservation of the ecosystems (Musa 2008: 7-10).

Political institutionalisation, governance and leadership through the LCBC should be enhanced. The LCBC is a supranational body charged with managing the Lake Chad countries (and neighbouring CAR and Libya) and other shared water resources of the Basin; preserving the ecosystems of the Lake Chad Conventional Basin; promoting regional integration, peace and security across the Basin, monitoring regulation and harmonisation of the basin and its natural resources (FAO 2017: 12). The Lake Chad Replenishment Project requires the damming of the Oubangui River at Palambo in the CAR and channelling some of its water through a navigable channel to Lake Chad, with the objectives of rehabilitating the lake, rebuilding its ecosystem, reconstituting its biodiversity and safeguarding it for present and future generations. (Onuoha 2008: 57). To this end, it is important to strengthen the institutional framework of LCBC to achieve these objectives and action plans as well as check unilateral actions by LCB countries, political conflicts as well as enhance its effectiveness in preventing conflicts.

It is equally important to reinforce the capacity building of the security forces and civilian government personnel on their obligations and people's rights under human rights and humanitarian law standards, and strengthen the accountability mechanisms (Oxfam 2017: 7). Hence, it is important to strengthen the capacities of the people, systems and institutions in such a way that supports their immediate recovery and reduces chronic socio-economic, political and ecological drivers of vulnerability and conflict (Mercy Corps February 2017).

Cross-cutting researches should also be conducted to assess the impacts of the crises on food security and livelihoods (seed system security evaluation, livestock and pastoralism, fisheries, trade, impacts on the local economies, small and medium enterprises, etc.) with a focus on women, girls and youth. The state governments should always seek the



support of non-state actors for efficient mapping, data collection and consolidation of data on the number and profiles of refugees, IDPs, returnees and host communities affected by the crises.

It is also important to adopt a smart market based economic recovery plans and programmes and an inclusive market expansion programme. These programmes can constitute engaging in regional market systems and cross-border value chains. This will be aimed at creating market outsources that can support the different populations while making attempts to reduce their vulnerabilities. This can also include training for traders, marketers and transporters of goods to have access to the regional markets and as a result, facilitate regional market growth in the region. Programmes can also be tailored to target pastoralists and agro-pastoralists on diverse livelihood options they can exploit to reduce the competition over the scarce resources that the LCB can offer them. This support system will also encourage their learning on adaptation to the different climatic changes.

The governments of the affected countries must increase their capacities to address the needs of the rural population in the region by decentralising technical services in the agriculture, fisheries and livestock sectors and not only rely on resource partners to provide basic services. Beyond this, programmatic designs on safe migration to improve the resilience of communities to make better choices on migration should be set up and the opportunities to build their capacities to manage the stresses and burdens that come with migration should be created. To a large extent, this will ensure that the negative consequences of migration into LCB are drastically reduced, which will further serve as a negating coping mechanism against labour migration.

The internally displaced and host communities' immediate needs must be addressed from a humanitarian dimension. It is expedient to meet their vulnerability needs and reduce their dependence on negative coping mechanisms. What this means is that it is important to synergise to meet the immediate needs of food and nutrition, health, water and sanitation, shelter and protection. Again, it is salient to support reintegration and recovery (livelihoods and economic recovery) and psychosocial support (Mercy Corp 2017: 8-10).

## References

- Action Against Hunger and Danish Refugee Council (November 2017):  
Hunger and displacement: Views and solutions from the field  
Lake Chad Basin. <https://drc.ngo/media/4090583/lake-chad-basin-drc-acf-final.pdf> as retrieved on the 01/02/18
- Bain, David (2007): Depletion of Renewable Environmental  
Resources. A presentation at the 12<sup>th</sup> meeting of the London  
group on environmental accounting in Rome. *Australian Bureau  
of Statistics*.  
[http://mdgs.un.org/unsd/envaccounting/seearev/docs/LG12\\_14a.pdf](http://mdgs.un.org/unsd/envaccounting/seearev/docs/LG12_14a.pdf)  
.pdf as retrieved on the 01/02/18
- Dorsch, M. J., Tornblom, K. Y. and Kazemi, Ali (2017): Resource  
Valuation: A Review of Resource Theories and their Implications for  
Understanding Consumer Behaviour: *Journal of the Association for  
Consumer Research*, pp. 5-25, <https://www.journals.uchicago.edu>, as  
retrieved on 13/06/18
- Food and Agriculture Organisation (FAO) of the United Nations,  
(2017): Lake Chad Basin crisis response strategy (2017–2019):  
Mitigating the impact of the crisis and strengthening the  
resilience and food security of conflict-affected communities.  
Rome: Food and Agriculture Organization of The United  
Nations.
- GIZ, (n.d.): Report on the State of the Lake Chad Basin Ecosystem.  
[http://www.cbtl.org/sites/default/files/download\\_documents/report\\_on\\_the\\_state\\_of\\_the\\_lake\\_chad\\_basin\\_ecosystem.pdf](http://www.cbtl.org/sites/default/files/download_documents/report_on_the_state_of_the_lake_chad_basin_ecosystem.pdf) as  
retrieved on the 01/02/18

- Hall, E. L. (2009): Conflict for Resources: Water in the Lake Chad Basin, A Monograph. School of Advanced Military Studies United States Army Command and General Staff College Fort Leavenworth, Kansas. <https://www.dtic.mil/dtic/tr/fulltext/u2/a505231.pdf> as retrieved on the 01/02/18
- Magdoff, Fred (2013): The Depletion of the World's Natural Resource: Is Population the Problem? *University of Vermont: Monthly Review Press* <https://monthlyreview.org/2013/01/01/global-resource-depletion/> as retrieved on the 01/02/18
- Mercy Corps (February 2017): Lake Chad Basin: Mercy Corps position paper. <https://www.mercycorps.org/research-resources/lake-chad-basin-position-paper> as retrieved on the 01/02/18
- Musa, I. K. (2008): Saving Lake Chad. Proceedings of Sirte Roundtable, Libya for Lake Chad Basin Commission (LCBC) and International Commission of Irrigation and Drainage (ICRD), Ndjamena and New Delhi.
- Mwanika, Philip A. N. (2010): Natural Resource Conflict: Management Processes and Strategies. *Institute for Security Studies (ISS)*. Paper 216. <https://www.files.ethz.ch/isn/136685/PAPER216.pdf> as retrieved on the 01/02/18
- Niasse, Madiodio (2005): Climate-induced Water Conflict Risks in West Africa: Recognizing and Coping with Increasing Climate Impacts on Shared Watercourses. Oslo: Centre for the Study of Civil War, International Peace Research Institute, Oslo (PRIO) & Centre for International Environmental and Climate Research

- at the University of Oslo (CICERO).  
[https://www.researchgate.net/publication/237699436\\_Climate-Induced\\_Water\\_Conflict\\_Risks\\_in\\_West\\_Africa\\_Recognizing\\_and\\_Coping\\_with\\_Increasing\\_Climate\\_Impacts\\_on\\_Shared\\_Watercourses](https://www.researchgate.net/publication/237699436_Climate-Induced_Water_Conflict_Risks_in_West_Africa_Recognizing_and_Coping_with_Increasing_Climate_Impacts_on_Shared_Watercourses) as retrieved on the 01/02/18
- Onuoha, F. C. (2008): Environmental Degradation, Livelihood and Conflicts: A focus on the Implications of the Diminishing Water Resources of Lake Chad for North-eastern Nigeria. *African Centre for Strategic Research and Studies, National Defence (formerly War) College, Abuja.*  
<https://www.ajol.info/index.php/ajcr/article/download/39425/59589> as retrieved on the 01/02/18
- Oxfam (February, 2017a). Red Gold and Fishing in the Lake Chad Basin: Restoring Destroyed Livelihoods and Protecting People in Niger's Diffa Region. An Oxfam Briefing Note.  
[https://www.oxfam.org/sites/www.oxfam.org/files/file\\_attachments/bn-red-gold-fishing-lake-chad-010217-en.pdf](https://www.oxfam.org/sites/www.oxfam.org/files/file_attachments/bn-red-gold-fishing-lake-chad-010217-en.pdf) as retrieved on the 01/02/18
- (2016b). Report: Lake Chad's Unseen Crises: Voices of Refugees and Internally Displaced People from Niger and Nigeria. Oxfam House, John Smith Drive, Cowley, Oxford: Oxfam International.
- Steer, Andrew (2013): Resource Depletion, Climate Change and Economic Growth. Working paper series 5. Global Citizen Foundation.  
[http://www.gcf.ch/wp-content/uploads/2013/06/GCF\\_Steer-working-paper-5\\_6.20.13.pdf](http://www.gcf.ch/wp-content/uploads/2013/06/GCF_Steer-working-paper-5_6.20.13.pdf) as retrieved on the 01/02/18

- United Nations Environment Programme (2015). Natural resources and conflict: A guide for mediation practitioners. Nairobi: United Nations Department of Political Affairs. [https://wedocs.unep.org/bitstream/handle/20.500.11822/9294/Natural\\_resources\\_and\\_conflic.pdf?sequence=2&isAllowed=y](https://wedocs.unep.org/bitstream/handle/20.500.11822/9294/Natural_resources_and_conflic.pdf?sequence=2&isAllowed=y) as retrieved on 01/02/18
- United Nations International Children's Emergency Fund (UNICEF) (2017): UNICEF's response to the Lake Chad Basin crisis 2017. A UNICEF's report on 'for every child'. [https://www.unicef.org/wcaro/OSLO\\_LCB\\_Advocacy\\_Note\\_Final\\_Low\\_Res.pdf](https://www.unicef.org/wcaro/OSLO_LCB_Advocacy_Note_Final_Low_Res.pdf) as retrieved on the 01/02/18
- United Nations Population Fund (UNFPA) West and Central Africa Regional Office (2017): Demographic Dynamics and Crises of Countries around Lake Chad, Route du King Fahd Palace, Almadies. Dakar: UNFPA.
- United States Institute of Peace (USIP) (2007): Natural resource, conflict and conflict resolution. A study guide series on Peace and Conflict. Washington DC: USIP. <https://www.usip.org/sites/default/files/file/08sg.pdf> as retrieved on the 01/02/18
- World Food Programme (WFP) (November 2017): Insecurity in the Lake Chad Basin – regional impact situation report, No 32. <https://reliefweb.int/report/nigeria/insecurity-lake-chad-basin-regional-impact-situation-report-32-30-november-2017> as retrieved on the 01/02/18

## Chapter 5

### **Reducing Flood Risk through Community Participation in Ibadan, Nigeria**

Bolanle Wahab<sup>1</sup> and Ayobola Faboyede<sup>2</sup>

<sup>1,2</sup>Department of Urban and Regional Planning,  
University of Ibadan, Ibadan.  
Correspondence: bolanle\_wahab@yahoo.com

#### **5.1 Introduction**

In the recent years, the emergence of the discourse on the scale, frequency and adverse effects of disasters on the global communities and the physical environment have drawn worldwide attention to the necessity of community consultation, sensitisation and participation as some key strategies of supporting risk management so as to ensure sustainable development (Wahab 2015). In the Asia-Pacific region, on the average, more than 70,000 people have been killed and more than 200 million people affected per year from 2001 to 2010 by droughts, floods, cyclones, tsunamis, earthquakes, wildfires and other disasters associated with natural hazards (UNESCAP 2011).

Every year, more than 200 million people are affected. There have been increasing incidences of natural hazards, such as flood, and increasing impacts of climate change on natural and human systems (IPCC 2014). The risks that ensue are unevenly distributed with the disadvantaged communities of the developing countries most impacted (IPCC 2014; Stam 2015). People who live in poverty and adverse socio-economic conditions are highly vulnerable to disasters (Robas and Robas 2014).

Flood disaster has assumed a dangerous dimension in Nigeria lately, with far-reaching implications for the location, its physical characteristics, functional efficiency and quality of her rural and urban settlements. In 2012, over 80 per cent of the 36 states experienced flooding (Wahab 2015). In Nigeria, like many other developing countries, flood affects and displaces more people than any other disaster. It also causes more damage to properties. At least 20 per cent of the population is at risk from one form of flooding or another (Emeribeole 2015).

Evidently, the country has experienced devastating floods, which affected millions of people and caused losses in billions of US dollars (NEMA 2013). Specifically, over the period 1985 to 2014, flooding in Nigeria has affected more than 11 million lives with a total of 1100 deaths and property damage exceeding 17 billion US dollar (Nkwunonwo *et al.* 2015). The Ibadan metropolis has, for a long time, suffered varying degrees of flood disasters with extremely high externalities due to an array of factors, the most prominent of which could be attributed to human behaviour (Ajayi *et al.* 2012). The Nigeria Hydrological Services Agency (NIHSA) in its 2018 annual flood outlook warned that the 34 states located in the flood-prone areas stand the risk of river and coastal flooding and should prepare for floods in 2018. Specifically, it predicted flooding in the 32 of the 36 states and in the 318 of the 774 LGAs with 78 LGAs at high risk including Sokoto, Niger, Benue, Anambra, Niger Delta, Lagos, Bayelsa, Rivers, Delta and Ondo. The cities predicted to experience flash and urban flooding due to poor drainage systems in 2018 include Lagos, Port Harcourt, Sokoto, Kaduna, Yola, Abuja, Maiduguri, Osogbo, Ilorin and Ibadan (Ikpefan and Okeke 2018). This situation calls for some concerted efforts and commitment of all stakeholders in Nigeria to raise the general



awareness of their communities towards the challenges occurring as a result of flood risks.

The Federal Government of Nigeria, with the support of the United Nations Development Programme (UNDP 2007), developed a draft National Plan of Action (NPA) covering 2006-2015 for the implementation of disaster risk reduction (DRR) (NEMA 2008; FRN 2010). The NPA was inspired by the need to build the resilience of vulnerable communities to all forms of disasters across the country with an emphasis on disaster risk reduction strategies (DRRS). Some of the principles of DRRS emphasised in the national plan of action include: being people-oriented and locally relevant; participatory; poverty reduction focused; promote education and increase awareness on local hazards and disaster risk situation (NEMA 2008). The NPA also recognises structural and non-structural mechanisms as some key strategies for DRR. By this recognition, it has become apparent that the institutionalisation of non-structural measures, disaster preparedness and improvement of the coping capacity of disaster-affected communities are very important in mitigating flood occurrences. The stakeholders in Nigeria are recognising the imperative of exploring non-structural flood risk management measures (Ajayi *et al.* 2012). Also, the citizens' participation in preventive actions and remedial programmes is central to DRR because the primary level of disaster occurrence and impact lie at the community level. Therefore, local leaders and opinion moulders drawn from the various social-cultural, economic and political sectors of society have to assume primary responsibility for the protection of their respective communities (Olorunfemi and Adebimpe 2008).

The common tradition of DRR regulations focuses on describing the roles and responsibilities of various government departments, particularly at the national level. However, a recent National Disaster

Framework issued by the FGN (2010: 16) recognised the need for the participation of the community in disaster risk management by extending DRR activities to the grassroots level and classified community structures and roles of communities in disaster management into three. These are:

- i. ensure commitment and preparedness of community members to disaster management;
- ii. sensitise and build the capacity of communities that constitute disaster fronts in preparation for initial response to disaster threats; and
- iii. mobilise community resources and build community capacity and resilience to prepare for, respond to and mitigate the impact of disasters.

However, as apt as this call is, there is no significant structure in place to implement the roles assigned to the communities. One of the most frequent criticisms levelled against coping with disaster risks has been the ‘top-down’ approach, leaving communities out of the process (Stam 2015). A ‘bottom-up’ approach, however, would be the most effective way to implement disaster risk management (DRM) successfully by involving the community (UNIDNDR 1994). Therefore, there is the need to expand the mandate of DRR activities to incorporate the role of community-based organisations in decision-making and management (International Federation of Red Cross and Red Crescent Societies [IFRC] 2010).

Flooding has been a major disaster in the city of Ibadan over the past seven decades with devastating destructions to lives and properties. Ibadan has a long history of flooding usually during the rainy season. The flood disasters of 1948, 1963, 1978, 1980, 1985, 1987 and 1990 were destructive and fatal (Eludoyin, Akinbode and Archibong 2007). Following the frequent and severe flood disasters occurrences in Ibadan

and the seeming inadequate government efforts to curtail it, this study examined the nature of community participation in flood risk reduction in the flood-affected communities.

## **5.2 Literature Review**

The DRR is defined as the practice of reducing disaster risks through some systematic efforts to analyse and manage the causal factors of disasters, including through reduced exposure to hazards, lessened vulnerability of people and property, improved preparedness for adverse events, and effective and efficient land and environment management strategy (UNISDR 2002 and Van Manen 2014). It consists of measures designed to protect the livelihoods of communities and individuals from the impact of hazards with regard to losses in lives and the social, economic and environmental assets of individuals and communities (Inforesources 2009 and ISDR 2009).

Not all hazards automatically result in disaster; the determinant drivers that turn hazards into catastrophic events are the level of vulnerability and the degree of susceptibility of a population to disaster risk (Birkmann *et al.* 2013). With the growing evidence of flood vulnerability, most flood-related disasters are not primarily caused by natural disasters. It has been acknowledged that the primary determinant factors are largely human activities that involve historical, cultural and socio-political relations (Vojinović 2015). The success of flood risk reduction largely depends on a knowledge-based decision, a robust institutional framework and flood risk communication. The creation of awareness in stakeholders and local communities regarding flooding and its impacts is driven by flood risk communication (Nkwunonwo 2016).

The DRR focuses on three activities, namely:

- a. mitigation: eliminating the risk to the people or reducing the frequency, scale, intensity and impact of hazards;
- b. preparedness: strengthening the capacity of communities to withstand, respond to and recover from hazards, and of the government and implementing partners to establish speedy and appropriate interventions when the communities' capacities are overwhelmed; and
- c. advocacy: positively influencing the environmental, political, social and economic issues that contribute to the causes and magnitude of impact of hazards (Madu and Kuei 2017).

A community's participation plays a key role in each step in flood risk management (mitigation, preparedness, response to and recovery from flood disasters and advocacy). Community participation is, therefore, essential for a successful flood risk management plans (World Meteorological Organisation [WMO] 2008). It will reduce to the barest minimum, and possibly eliminate, the reactionary approach to flood risk management, which has characterised the NEMA and State Emergency Management Agencies (SEMA). Community sensitisation and participation in risk management represent the process by which communities who are mostly affected by the incidence of risks, understand the nature of the risks and the interlinks with their livelihoods and their potential for mitigating the risks by their own initiative for a sustained period (Bahir 2010).

The DRR's major goal is to motivate communities towards risk identification, risk management and reduction of vulnerability (Wand *et al.* 2015). Drishti (2015: 1) stated that Community-based Disaster Risk Management (CBDRM) is hinged on enhancing the communities' capacity to cope with disaster risks and reduce vulnerability by developing safer and more resilient communities. This involves the change of focus from the traditional emergency response to planned

activities that would mitigate or prevent disasters (Jorgelina *et al.* 2011) thereby promoting and ensuring healthy community living and sustainable development. Community or citizen's participation in DRR is, therefore, the involvement of all stakeholders including women and men, the girl-child, boys, the youth, the elderly, the people living with disabilities, the literates and unlettered, the natives and immigrants in one or all types of DRR activities within the community. It is an approach that best embraces the recent calls for a bottom-up approach to environmental issues (Iyi and Ugwuanyi 2014). It enhances the communities' understanding of the possibilities and strategies of reversing the current alarming condition of the risks of flood disaster.

The significances of community sensitisation and participation in risk reduction have long been recognised in promoting a culture of safety by reducing local vulnerabilities, disaster impacts and building capacities (McLaughlin 2007). These approaches have been practised by various stakeholders, such as community groups, national and international organisations and government departments for over two decades in South-East Asian countries like Vietnam and Indonesia (McLaughlin 2007) and in Philippines (Wahab 2015). While national, state and local authorities have very vital roles to play in DRM, it is the active participation and involvement of communities at the grassroots that make the real difference. When the entire members of a community are involved in the whole process of risk management, their felt and real needs, as well as inherent resources, are easily identified, profiled and considered for utilisation. Their problems will be addressed with appropriate interventions, and the probabilities for a huge loss of life and properties will be minimised (Wahab 2015).

There are many indicators and criteria that have been used in the literature in measuring a community's involvement in DRR. These have been synthesised into seven indicators to include: community

participation, application of multi-sectoral and multi-disciplinary approaches, information sharing and cooperation in a dynamic framework, education and training, public awareness, ownership and sustainability (Rahman 2008; Sayers *et al.* 2013; Stam 2015 and UNISDR 2005). For example, to reduce the flood disaster risks in Bangladesh, communities take certain steps to cope with the severity of a disaster individually. According to Saidul Huq (2016), some of the actions taken included; public awareness creation, proper utilisation of climate information, appropriate prevention and mitigation measures, showing mutual respect among stakeholders, timely communication, and specialised training on regular basis and inclusive community participation.

Traditionally, most communities living in flood-prone areas have always co-existed with floods. Many studies recognise such communities to have a traditional flood culture, characterised by adjustments to mitigate flood damage (Mwango 2010). Flood forecasting and warning are some of the most important tools to reduce flood risks and minimise the impact on life and property (Mwango 2010; Sharma 2002 and UNISDR 2005).

### **5.3 Methodology**

This study was conducted in Ibadan, the capital of Oyo State. Ibadan is located approximately on latitude 70 25' North and Longitude 30 5' East. The city is sited about 145 km north of Lagos. Eleven LGAs were grouped to form what is called Ibadan region or Ibadan land. They are; Ibadan north, Ibadan north-east, Ibadan north-west, Ibadan south-east, Ibadan south-west, respectively, the Akinyele, Ido, Egbeda, Oluyole, Ona-Ara and Lagelu LGAs (*Figure 5.1*, below). The city has a tropical wet and dry climate, with a lengthy wet season and relatively constant temperatures throughout the course of the year. The wet season runs

Climate Change and Socio-ecological Transformation in Nigeria:  
Challenges and Opportunities

**Figure 5.1:** Map of Ibadan Metropolitan area in the Context of Oyo State, Nigeria

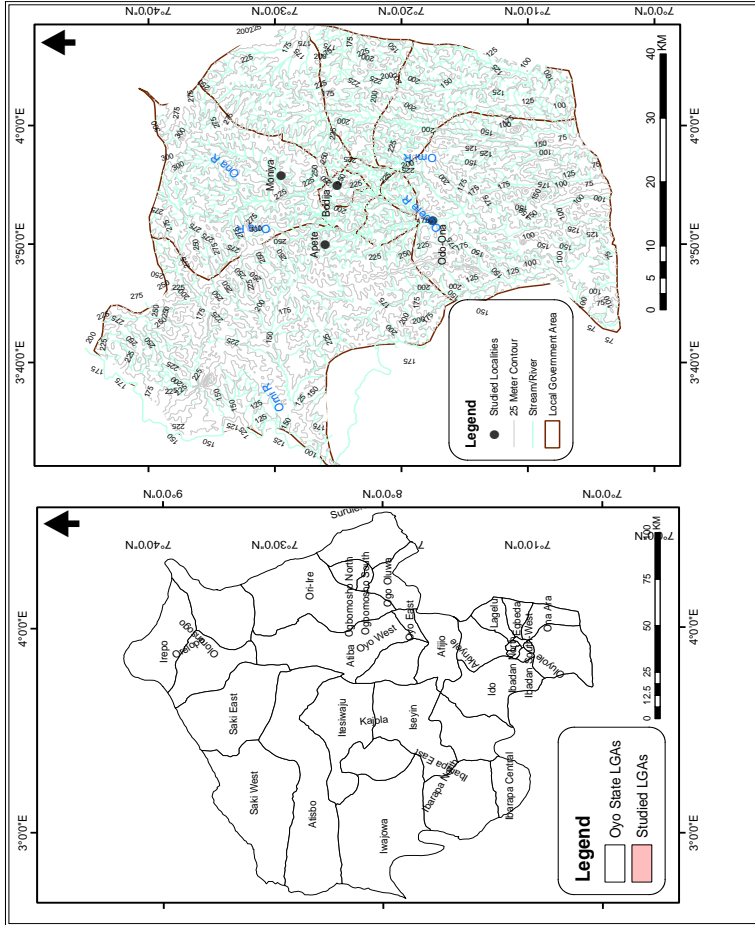

**Source:** Office of Surveyor General, Oyo State, Nigeria, 2011; drainage network extracted from Google image; and contours derived from Shuttle Radar Topographical Mapping (SRTM) data

**Table 5.1:** Profile of Flooding in Ibadan 1902–2013

<b>Date</b>	<b>Rainfall (mm)</b>	<b>Description and Estimated Damage to Properties</b>	<b>Major Affected Stream</b>
1902*	Unknown	Flooding of Oranyan swamp.	Alafara Stream
1924*	Unknown	Ogunpa overflowed its banks.	Ogunpa River
1956*	Unknown	Ogunpa flood which rendered many homeless and destroyed properties.	Ogunpa River
9-10 July 1951	161	Unknown	Ogunpa River
16-17 June 1955	173	Unknown	Ogunpa River
16 August 1960	178	Ogunpa flood disaster; destroyed 400 houses and other properties costing tens of thousands of naira.	Ogunpa River
27-28 August 1963	258	Ogunpa river overflowed its bank; at least 2 persons died; destroyed houses estimated at tens of thousands of naira.	Ogunpa River
14 May 1969	137	Ogunpa flood killed at least 2 persons and destroyed houses estimated at tens of thousands of naira.	Ogunpa River
20 April 1978	126	Ogunpa flood killed at least 2 persons and destroyed properties worth several millions of Naira at Old Gbagi market, Ogunpa Oyo, Omitowoju and Molete.	Ogunpa River; Kudeti
31 August 1980	274	Sixth Ogunpa flood disaster and the most destructive and overwhelming ever in the history of Ibadan. More than 500 lives lost; over 50,000 people displaced. Over 300 million Naira properties destroyed.	Ogunpa main channel; Upper and Lower Tributaries of Ogunpa River;



Climate Change and Socio-ecological Transformation in Nigeria:  
Challenges and Opportunities

*Table 5.1* Continued

<b>Date</b>	<b>Rainfall (mm)</b>	<b>Description and Estimated Damage to Properties</b>	<b>Major Affected Stream</b>
1982**	Unknown	Unknown	Kudeti stream; Ogbere stream and Ona River Ogunpa River
1984(undated)**	Unknown	Unknown	Ogunpa River
April 1986 (Undated)**	Unknown	Unknown	Ogunpa River
June/July 1987 (Undated)**	Unknown	Unknown	Ogunpa River
April 1997 (Undated)**	151	Unknown	Kudeti; Alafara; Atere
26 August 2011***	187.5	Affected all the eleven local government areas in Ibadan region. Destroyed life and properties worth billions of naira.	Ona, Ogbere, Upper Course of Ogunpa, Orogun; Atere, Alafara, Omi, Alafara and Olokun

Table 5.1 Continued

Date	Rainfall (mm)	Description and Estimated Damage to Properties	Major Affected Stream
14 July 2012***	164	Roads and Bridges were washed away; destroyed life and properties.	Upper Course of Ogunpa at Dandaru; Ona River; Ogbere River. Onipepeye stream, Ona River,
23 September 2013****	Unknown	At least 2 persons dead and 1 injured.	Ogunpa River, Orogun stream.

**Source:** Nigeria Environmental Study Action/Team (NEST 1991: 107) and National Water Resources Institute (2011: 10); \*Tomori (2010), \*\*Akintola and Ikuyatum (2012: 199), Agbola *et al.* (2012: 208); \*\*\*Oyo State Task Force on Flood Prevention and Management (2011) and Nigeria Metrological Agency (NIMET) (2012); \*\*\*\*Atoyebi (2013) and Wahab (2013); Wahab and Falola (2017: 9).

from March through October, although August seems somewhat of a lull in precipitation. This lull nearly divides the wet season into two different wet seasons.

The urban growth and urbanisation witnessed in the city are widely attributed to the influx of rural migrants, because of the availability of economic opportunities such as the presence of industries, an array of institutions and infrastructural services (Owoeye and Ogundiran\_2014). The relief, vegetation, soil type and the general geology often influence

the nature of flooding in an area. Human activities have also influenced the amount of flooding over the years (ACE Geography 2014).

River flooding has been a recurrent disaster in Ibadan since early 1924 when Ogunpa River overflowed its banks as a result of a very heavy rainfall and the Ogunpa community was ravaged (*Table 5.1*). From 1951 to 2016, Ibadan experienced 16 flood disasters with high externalities (*Tables 5.1 and 5.2*). *Table 5.1* presents flood profile in Ibadan from 1902 to 2013, while *Table 5.2* presents some of the communities in seven LGAs that were affected by the flood from 1924 to 2016. Flooding has assumed almost an annual event in Ibadan. The city experienced enormous destructions to lives and property (*Table 5.1*) arising from the flood disasters of 1964, 1978, 1980, 1985, 1997 and 2011 (Akintola and Ikwuyatum 2006, 2012; Agbola *et al.* 2012), which occurred mostly in August, a period between the first rainfall peak and the rainfall break. The 1980 flood was caused by 274 mm of rainfall, the heaviest rain on record followed by the 1963 flood with the second heaviest recorded rainfall of 258 mm, while the August 2011 flood recorded the third heaviest rainfall of 187.5 mm (Agbola *et al.* 2012). The August 26, 2011 rainfall which started at 16:40 in the afternoon and continued until 23:00 late at night and was accompanied by some high winds of speeds of 65 km h<sup>-1</sup> (Oyo State Government 2011). The rainfall was most intense in a 70-minute period between 18:10 and 19:20 when 75 per cent or 140.63 mm of the rain fell. This translated to an average rainfall intensity of 127.84 mm h<sup>-1</sup> (National Water Resources Institute 2011).

**Table 5.2:** Flood-affected Communities in Ibadan Metropolis 1924-2016

<b>LGA</b>	<b>Affected Communities and Year</b>	<b>Impact of Disasters</b>
Akinyele	Idi-Ose, Osajin/Ola-Adua (2011); Ojoo (2011); Olode (2011); Abata-Kan (2011); Isokun (2011); Arulogun (2011); Isabiyi (2011); Lanibe (2011); Moniya (2011); Olomo 2011; Sasa (2011).	Lives lost and people displaced; Buildings submerged; Water sources polluted;
Ibadan North	Ogunpa (1924,1948, 1956, 1963, 1978, 1980, 1985,1987, 1990, 2011); Kajola (2011); Bodija (2011), Agodi (2011), Sango area (2011),	Farmlands and livestock destroyed;
Ibadan North West	Omitowoju (1978), Old-Gbagi market (1978); Idi Ishin (2011); NIHORT (2011),	Properties damaged;
Ibadan South East	Oranyan (1951); OgberePegba/ Fatusi, Molete (1978); Onipepeye 1980,	Culverts, bridges and drainage infrastructures destroyed;
Ibadan South West	Apata (2011, 2016); Omi Adio (2011); Arapaja (2011); Carpenter bus stop-Agbowo (2011).	Electricity infrastructure damaged;
Ido	Ajibode (2011); Agbebukola and Abidogun market (2016); Gbekuba (2011, 2016); Awotan (2011, 2014); Apete (2011, 2012, 2014, 2016); Olokun Stream and SAMOG Petrol Station Area, Apete, Faith Clinic/Hill-Top Tavern Hotel Area, Ijokodo (2011); Ologuneru, Eleyele, Ola-Adua (2011); Onigbodogi, Awotan (2011).	Environmental damage; Disruption of transportation services;
Oluyole	Orita, Arapaja, Challenge, Odo-Ona, Seven Up Area, Elewe (2011); Elere, (2011); Oluyole Estate (2011); Abonde (2011); Foworogin (2011); Oke Ayo (2011, 2016).	Land degradation.

**Sources:** NEST, 1991; National Water Resources Institute, 2011; Nigerian Meteorological Services, Ibadan Station, 2011; Agbola *et al.*, 2012; Akintola and Ikwuyatum, 2012; World Bank 2014; Authors, 2016.

Excessive rainfall is not the sole cause of incessant flooding in Ibadan. Agbola *et al.* (2012) classified the causes into four:

- i. hydrological;

- ii. waste management;
- iii. institutional; and
- iv. awareness factors.

The literature on the causes of flooding in the city presents other causes to include: heavy rainfalls; rapid population growth; increase in settlement areas; the competing land uses; uncoordinated urban development; building on floodplains and fragile ecological areas or close to riverbanks; poor drainage system, inadequate and weak hydraulic infrastructure; dam breaking; ignorance; lack of early warning information; increased impervious surfaces; ineffective physical planning and development control; activities of land speculators; act of god and punishment for wrongdoing; and human behaviour, especially, indiscriminate solid waste disposal and blockage of drains (Akintola and Ikwuyatum 2006, 2012; Oyo State Government, 2011; Agbola *et al.* 2012; NEST, 1991 Osayomi and Oladosu 2016; Akanle *et al.* 2015; Wahab and Falola 2017).

*Figures 5.2 (a) to (h)* illustrate some of the causes of flood. The effects of the flood disasters are varied and impactful, and include: loss of lives and damages to properties; individual and family displacements; diseases; destruction of physical, service and social infrastructure; disruption of transportation services; alterations in the natural drainage and river basin patterns; deforestation, destruction of farmlands, crops and livestock; environmental damage, land degradation and climate change. *Table 5.3* shows that the losses from the August 1980 flood disaster were estimated at over ₦300 million (Nigerian naira, or USD 1.92 million), while over 500 lives were lost (Akintola 1994). The damaged culverts and bridges in the 2011 flood were estimated at ₦2.1 billion (Oyo State Government 2011). Infrastructural damages and lost properties at the University of Ibadan in the 2011 flood disaster were estimated at ₦10 billion (Agbola *et al.* 2012).

In response to the frequent flooding, the state government embarked on structural measures to mitigate it starting with the channelisation of Ogunpa River, which lasted from 1989 to 2008 through a World Bank Assisted Project. This was followed by intermittent dredging of river channels, which unfortunately has not halted the disaster occurrence. The August 2011 flood, in which 2,105 buildings were flooded in the entire 11 LGAs, attracted assistance of the World Bank to provide a low-interest loan of \$200 million (₦6.1 billion; \$1= 305) loan to re-build damaged culverts, bridges and construct standard drainages in addition to preparing a drainage-, waste management and physical development master plans for the city. So far, however, the structural measures seem inadequate to mitigate the causes and reduce the effects of flooding in Ibadan as the human behavioural aspects appear not to have been seriously addressed. The engineering solutions to flooding, according to Nash (1982), had not required little or no change in individual or collective human behaviour. Thus, understanding a community's perception of the causes and impacts of flood, and their level of participation in flood risk reduction measures motivated this study.

Six LGAs that experienced more flood disasters were purposively selected based on the frequency and severity of the disasters. They were: Akinyele, Ibadan North, Ibadan North-West, Ibadan South-West, Ido and Oluyole. The sampling frame for the study was 1,314 flooded buildings in the six LGAs in August 2011. The sampling elements were landlords and/or heads of households of the affected residential buildings. A random choice of 384 households corresponding to 29.2 per cent of the flood-affected buildings in each of the LGAs was made. A structured questionnaire was administered to the randomly selected 384 household heads for information on the causes of flood disasters, the resulting impacts, disaster knowledge, practised risk reduction

Climate Change and Socio-ecological Transformation in Nigeria:  
Challenges and Opportunities

**Figures 5.2** (a) and (b): The August 26, 2011 flood swept away the only bridge on Ona River at Apete that links Apete community to the rest of the city; a fragile bamboo bridge was constructed by the community to provide a temporary passage.



Source: Wahab, 2011

**Figures 5.3:** (c) Drainage channel and hydraulic structure blocked by solid waste along the University of Ibadan wall fence  
(d) Solid waste dumped on Mokola stream, Mokola area



**Sources:** (c) OYSG, 2011, (d) Authors', 2016



Climate Change and Socio-ecological Transformation in Nigeria:  
Challenges and Opportunities

- Figures 5.4:** (e) Residential building constructed on river channel/flood plain at Odo-Ona area  
(f) Blocked drain along the Durotolu-Apete market road, Apete area  
(g) Blocked drain along Apete-Osajin-Ajibode road  
(h) Stormwater channel silted with solid waste along Bashorun-Gate road, after Oje market



*5 Reducing Flood Risk through Community Participation in Ibadan, Nigeria*  
**Wahab, B. and Faboyede, A.**



**Sources:** (e, f, g and h) OYSG, 2011

Climate Change and Socio-ecological Transformation in Nigeria:  
Challenges and Opportunities

measures and community participation. *Table 5.3* presents the summary of the sample frame and sample size (29.2 per cent) in the order of the affected communities and corresponding LGAs.

**Table 5.3:** Flood-affected Communities, Sample Frame and Size

<b>S/ No</b>	<b>Local Govern- ment Areas</b>	<b>Communities Sampled</b>	<b>Number of Flooded Buildings</b>	<b>Sampl e Size (29.2% )</b>
1	Akinyele	Ajibade, Idi-Oro, Osajin, Ola-Adua, Ojoo, Olode, Alabata, Isokun, Arulogun, Isabiya, Lanibe, Moniya, Ojoomo, Sasa.	382	112
2	Ibadan North	Ikolaba, Bodija, Agbowo, University of Ibadan, Agodi, Sango, Polytechnic quarters, UCH, Yemetu, Agbeni, Kajola, Okoro, Mokola, Oke-Itunu.	260	76
3	Ibadan North West	Dugbe, Yidi, Ayeye, Idikan, Oje, Opo-Yeosa, Idi-ishin.	162	47
4	Ibadan South West	Oke Ado, Aleshinloye market, Apata, Omi-Adio, Iyana church, Adeyigbe, Ring road, NIHORT.	369	108
5	Oluyole	Elebu, Odo-ona Elewe, Oke Ayo, Arapaja, Agbaje, Orita Challenge, Soka, Oluyole Estate, Olonde, Muslim, Aba-Nla, Ogbere-Mosfala.	63	18
6	Ido	Apete, Ologuneru, Ijokodo, Jeje, Eleyele	78	23
<b>TOTAL</b>			<b>1314</b>	<b>384</b>

Out of the 384 copies of the questionnaire administered, only 361 were good enough for analysis. The starting point was randomly selected using the table of random numbers. The primary data obtained were analysed with descriptive statistical models, while frequencies and percentages were used to present the data. The respondents were interviewed between 8 am and 6 pm over a period of 27 days, followed by a few follow-up site visits over a period of 3 weeks to cross-check some issues or claims and initial observations. The structured questionnaire, written in English, were administered by trained graduate assistants who transcribed the native language of those respondents who were not conversant with English. Interview guides were used to interview agencies' officials including Oyo State Emergency Management Agency (OYSEMA), Social Service Department of Ibadan North LGA and Centre for Disaster Risk and Crisis Reduction (CDRCR) to get professional feedback on the community practices on flood risk reduction in Ibadan metropolis. Ethical issues were considered, especially, regarding the purpose of the study, respondents' right to privacy, contents of the research instrument and the confidentiality of the data. The informed consent and willingness of the respondents to participate in the survey were obtained.

#### **5.4 Results and Discussion**

The majority (74.8 per cent) of the respondents had lived in their communities for over 10 years. While 41.6 per cent had lived in their communities for between 11-20 years, only 9.1 per cent had lived in their communities for more than 30 years (*Table 5.4*). Therefore, the respondents should have adequate experience and knowledge of previous disasters and strategies adopted over the years for DRR. Income distribution of respondents revealed that 16.6 per cent of respondents earned below ₦20,000 monthly, 41.6 per cent (the highest

number) earned between ₦20,000 and ₦30,000, followed by 20.2 per cent who earned above ₦50,000 monthly while 8.0 per cent of the respondents earned between ₦31,000 and ₦40,000 (*Table 5.4*). This implies that the respondents were mostly low-income to middle-income earners. The income structure influences the choice of risk reduction measures, such as the location of houses in areas that are flood prone or acquiring land in the floodplains, which tends to be cheaper compared to dry and stable land.

The findings on the occupation of the respondents (*Table 5.4*) revealed that 29.4 per cent (the highest proportion) were traders, followed by civil servants (22.7 per cent), artisans (3.0 per cent) and farmers (5.0 per cent). While 4.2 per cent of the respondents were engaged in other occupations like entrepreneurship, banking, telecommunication and factory works, 16.1 per cent were unemployed. The information on house ownership status revealed that 27.1 per cent of the respondents owned the houses which they lived in; 54.6 per cent rented the houses while 18.3 per cent were squatters. This implies that there were more tenants than owner-occupiers (landlords/ladies) within the study area. One can infer that the landowners after being impacted by flood hazards relocated elsewhere thereby placing the flood exposed buildings in the housing market for renters who are mostly constrained to seek accommodation in such vulnerable conditions and locations owing to poverty.

The use of the buildings revealed that more than two-thirds (71.7 per cent) of the buildings were used for residential purposes; 10.0 per cent, 3.0 per cent and 2.2 per cent were used for commercial, religious and educational purposes respectively. While 0.8 per cent was used for medical purposes, 12.2 per cent were for mixed uses (*Table 5.4*).

**Table 5.4:** Socio-economic Attributes of Respondents

<b>Variables</b>	<b>Frequency</b>	<b>Percentage</b>
<b>A. Length of Residence</b>		
1-10 years	91	25.2
11-20 years	150	41.6
21-30 years	87	24.1
Above 30 years	33	9.1
<b>B. Average Monthly Income (₦)</b>		
Below 20,000	60	16.6
20,000-30,000	150	41.6
31,000-40,000	29	8.0
41,000-50,000	49	13.6
Above 50,000	73	20.2
<b>C. Occupation</b>		
Civil Service	82	22.7
Trading	106	29.4
Artisanship	11	3.0
Student	71	19.7
Farming	18	5.0
Unemployed	58	16.1
Others	15	4.2
<b>D. Ownership Status</b>		
House Owner	98	27.1
Renter	197	54.6
Squatter	66	18.3
<b>E. Use of Building</b>		
Residential	259	71.7
Commercial	36	10.0
Religious	11	3.0
Educational	8	2.2
Medical	3	0.8
Mixed use	44	12.2
<i>N=361</i>		
<i>Note: at the time of survey, ₦160 = 1 USD</i>		

Climate Change and Socio-ecological Transformation in Nigeria:  
Challenges and Opportunities

The respondents were asked for what they perceived as the causes of flood disasters in the city. *Table 5.5* (below) presents the diverse opinions of the respondents in order of magnitude ranging from dam breaking and release of excessive volume of water from dams (19.9 per cent); indiscriminate solid waste and sewage disposal in drainage channels (17.5 per cent); lack of drainage channels and poor existing ones (14.4 per cent) and heavy rainstorm (13.6 per cent).

**Table 5.5:** Perceived Causes of Flood Disasters in Respondents' Communities

Causes	Frequency	Percentage
Dam breaking or release of water from dams	72	19.9
Wrong solid waste and sewage disposal method	63	17.5
Poor or lack of drainage system	52	14.4
Rainstorm	49	13.6
Act-of-God	42	11.6
Poor urban planning	26	7.2
Deforestation	18	5.0
Illegal structure on/across drainage channels	15	4.2
Climate change	11	3.0
Nature of terrain	7	1.9
Collapsed bridge	6	1.7
<b>Total</b>	<b>361</b>	<b>100.0</b>

Other respondents claimed that the floods were caused by act-of-god (11.6 per cent); poor urban planning (7.2 per cent); deforestation (5.0 per cent); illegal structures built on drainage channels (4.2 per cent); climate change (3.0 per cent); nature of terrain/topography (1.9 per cent) and collapsed bridges (1.7 per cent). The causes of flooding as identified by the respondents in this study corroborate those reported in Akintola (1994), Oguntala and Oguntoyinbo (1982), Ogba and Utang (2008), Adewale, Sangodoyin and Adamowski (2010) and Thakur *et al.* (2011) on rainfall intensity, topography, climate change, blocked drainages; and those of Agbola *et al.* (2012), Ogba and Utang (2008) and Adelekan (2010) on deforestation, dam breaking, heavy rainfall, dumping refuse in drainage channels and inadequate waste management; and that of Akanle *et al.* (2015) and Osayomi and Oladosu (2016) on act-of-god; and those of Falola and Wahab (2017) on poor urban planning, narrow drainage channels and solid waste-blocked drains.

The communities would become active in reducing disaster risks and/or exert pressure on the government to do so only if they are aware of them (IFRC 2010). The majority of the community members were aware of flood risks and, as such, 77.8 per cent recognised the importance of community participation in flood prevention or relief actions. This is in view of their (61.2 per cent) belief that the government might not be able to embark on flood-risk reduction and post-disaster reconstruction. This is in line with the principal finding of the Global Network of Civil Society Networks for Disaster Reduction (GNCSNDR) (2009) that communities do not feel adequately engaged in planning and decision-making about DRR. Despite the high level of awareness of flood risk, community participation in flood risk reduction was low as less than a quarter (24.9 per cent) of the respondents had actively engaged in flood disaster prevention activities. The majority (58.2 per cent) had never



taken part in any individual or group pre-flood prevention or post-flood relief actions, while 16.9 per cent claimed ignorance of what actions to take or how to execute such actions. Should a flood disaster occur, 40.2 per cent of the respondents claimed that they were capable to control the event to avoid a huge loss (*Table 5.6*). This confidence, according to them, arose from the practice of preventive risk reduction actions to avoid triggering existing hazards. However, the majority (59.8 per cent) were not sure of their capability of controlling the hazard to avoid a huge loss.

**Table 5.6:** Capability to Control a Flood Disaster

<b>Disaster Capability</b>	<b>Control</b>	<b>No of respondents</b>	<b>Percentage</b>
Capable		145	40.2
Not capable		216	59.8
<b>Total</b>		361	100.0

Knowledge of flood disaster and the participation of local inhabitants are important in flood prevention and risk reduction. As revealed in *Table 5.7*, only 42.7 per cent of the respondents knew the mitigation actions to adopt if flooding occurred, while over a half (57.3 per cent) were not aware of the appropriate mitigation actions to adopt. The

**Table 5.7:** Knowledge of Flood Mitigation Actions

<b>Mitigation Knowledge</b>	<b>Frequency</b>	<b>Percentage</b>
Knowledgeable	154	42.7
Not Knowledgeable	207	57.3
<b>Total</b>	361	100.0

respondents who knew what to do listed ensuring good drainages around the house and proper disposal of solid waste as some of the major strategies adopted to reduce flood risks.

The community residents perceived that inadequate drainage was a major cause of flood disasters in the Ibadan metropolis; as a result, 28.5 per cent of the respondents embarked on periodic clearance and evacuation of debris and solid waste that silted up drainage channels and the expansion of narrow drains where necessary as part of their flood risk reduction strategies (*Table 5.8*). Other measures adopted included: construction of embankments (10.2 per cent); use of elevated walls and entrances (5.8 per cent); planting of trees (3.9 per cent), *Figures 5(i) and (j)*; relocation to flood-safe communities (8.9 per cent); public awareness and sensitisation of neighbours and community members on flood risks (23.8 per cent), and adherence to early warning information and instruction (13.0 per cent) (*Table 5.8*).

However, there was a seeming lack of organised or joint community-based engagement in flood risk reduction as most of the preventive activities in the area were championed by individual needs and executed at the individual or household level. This individualistic approach had been ineffective and inefficient. The inadequacy of the strategy had exposed the larger community to incessant flooding. This underscores the need for community-wide participatory interventions to reduce the community exposure to flood risk.

When asked if there was a difference in the impact of the flood as a result of the risk reduction measures adopted in their communities, 25.5 per cent of the respondents claimed that the measures were effective as they reduced the negative impact. However, a majority (64.0 per cent) of the respondents (suspected to be among those who never participated in any preventive actions) claimed that the measures did not change the

Climate Change and Socio-ecological Transformation in Nigeria:  
Challenges and Opportunities

impact, while 10.5 per cent were not sure. Those respondents, who claimed that there was no change, considered the awareness programmes as inadequate, selective and exclusive, not well publicised, no practical (even if demonstration) projects as examples and no agency collaboration with communities on enforcement of environmental regulations.

**Table 5.8:** Flood Risk Reduction Measures

Risk reduction measures	Frequency	Percentage
Adequate drainage system and periodic drainage clearance	103	28.5
Adequate sensitisation of people and public awareness	86	23.8
Early warnings about expected weather and rainfall patterns	47	13.0
Construction of embankments	37	10.2
Relocation to flood-safe areas	32	8.9
Elevated walls and entrances	21	5.8
Land use zoning	21	5.8
Tree planting	14	3.9
<b>Total</b>	<b>361</b>	<b>100.0</b>

**Source:** Authors' fieldwork, 2016

**Figure 5.5:** (i) Cleared block-lined drain at Gbekuba community, Ido LGA  
(j) Female children clearing an open drain at Morayo Hotel area, off Agbowo Street. The evacuated waste if not removed after a while, will find its way back into the drain.



Climate Change and Socio-ecological Transformation in Nigeria:  
Challenges and Opportunities

**Figures 5.6:** (k) and (l) Reinforced concrete embankment and wall fence constructed to prevent flooding at Yale Foods Limited, and Rhema Chapel respectively at Oluyole Industrial Estate, Oluyole LGA



**Source:** The authors of this chapter

**Figure 5.7 (m):** An elevated foundation wall and entrance to a building along Queen Elizabeth Road by Mokola roundabout



**Source:** The authors of this chapter

Although there were some form of community-level disaster planning and management meetings held at community and town halls and landlords/landladies' association meetings especially when flood warning reports were received from metrological stations, only 10.2 per cent of the respondents claimed that such reports had been effective in dealing with flood disaster in the communities. This is more so in situations where disaster response is routinely and takes the centre stage in the country as against DRR. According to Adejuwon and Aina (2014, p. 508), it can be deduced that what happened during the 2011 flood in Ibadan was at variance with the accepted norms in disaster

management. The findings of this study indicate that although some early warnings on the Ibadan flood were provided to the people who were at risk, appropriate and timely decisions were not taken by the people.

Some officials of the agencies and organisations engaged in disaster management in Ibadan were interviewed on what they had done to educate the communities on flood risk reduction. OYSEMA officials claimed to have carried out public sensitisation and education through train-the-trainer workshops, advocacy programmes and simulations. The CDRCR carried out periodic sensitisation campaigns to educate the public on what to be done before, during and after a disaster, particularly flooding. An official of the Social Services Department of Ibadan North LGA also claimed that the department trained some members of the public on DDR principles although the training was not regular owing to the paucity of fund.

Following the activities of the listed disaster management agencies, one-fourth (25.5 per cent) of the respondents claimed that there was a reduction in the impacts of the flood when the communities adopted the risk reduction measures which included: sensitisation of people, public awareness on flood risk hazards and relocation to safer ground. These, they claimed, resulted in little or no damage to property, and no loss of life. More than half (59.8 per cent) of the respondents were willing to further participate in rescue and relief actions during disasters and educate people on precautionary and preventive measures (24.9 per cent) against disasters if properly directed and taught the actions to take.

The majority (64.0 per cent) of the sampled respondents argued that risk reduction measures adopted in their communities did not change the impact of the flood disasters in their community, while 10.5 per cent of

the respondents cannot say whether the risk reduction methods had an impact on flood disaster reduction in their communities.

**Table 5.9:** Practiced Risk Reduction Measures Against Flood Disasters

<b>Risk reduction measures</b>	<b>Frequency</b>	<b>Percentage</b>
Adequate drainage system	103	28.5
Adequate sensitisation of people and public awareness	86	23.8
Early warnings about expected weather and rainfall patterns	47	13.0
Construction of embankments and wall fence	37	10.2
Relocation to safer grounds	32	8.9
Elevated walls and entrances	21	5.8
Land use zoning	21	5.8
Tree planting	14	3.9
Total	361	100.0

## **5.5 Conclusion and Recommendations**

The general objective of community participation in DRR is to save lives and prevent damage to properties by helping communities work to decrease their level of vulnerability and increase their capacity to reduce the impact of floods. Participation of community members and related stakeholders in flood management is essential in sustaining flood risk reduction process of a community in meeting intended aims and targets.



The analysis from the study indicated that the community members were involved in some level of DRR such as drainage clearance and/or expansion and proper waste disposal. However, findings indicate that while some early warning on the city floods were provided to the people who were at risk, they did not take appropriate and timely decisions. There is the need, therefore, for increased community participation in early warning systems in terms of prediction, dissemination of messages and prompt actions for effective flood disaster preparedness. Concerted efforts are required by the officials of community-based associations to mobilise their members to embrace more group initiatives and activities rather than rely on solo- and individualistic flood prevention actions, which are often inadequate, ineffective and not long-lasting. At the group level, more resources could be raised for programmes or projects and better results achieved.

In order to enhance the effectiveness of flood-risk measures in reducing the negative impact of flooding and also increase the confidence of community members, the state and local governments should organise in collaboration with communities, a yearly sensitisation and hands-on practical training on planning and execution of simple but effective flood-risk prevention programmes and projects in each of the 11 LGAs and 14 local council development areas (LCDAs) in Ibadan. Members of the Community Development Councils (CDCs) for each LGA should undertake follow-up actions with landowners in the different communities in order to sustain the flood-risk programmes and replicate the projects in various parts of the city.

Community participation cannot be effective if the members of the community do not have the basic knowledge of flood risk management and understand the community flood disaster management plan. The Ibadan communities need to be properly and adequately educated on the common causes of flooding and the risks involved in their

development activities especially of living or doing businesses in the floodplains and dangerous terrains, and also on the range of non-technological alternatives that could offer some measure of protection. Indigenous flood management and impact coping mechanisms need to be adopted along with modern techniques.

The OYSEMA in collaboration with the Ministry of Information and Culture should embark on a continuous education of Ibadan communities during town hall meetings and through the electronic media (radio and television jingles, stories and drama series), the print media, and indigenous communication platforms (local drummers and singers, local-level meetings and traditional festivals and events). This should be conducted in all the local languages. This is to promote a behavioural change aimed at revolutionising flood risk reduction practices in Ibadan.

The critical mass of community residents (75.1 per cent) who either never participated in or were ignorant of the risk prevention actions to undertake require very serious focus in the form of special awareness, sensitisation and induction programmes by a joint coalition of stakeholders consisting of Oyo State emergency management agency, local emergency management committee, NGOs, the academic and community- and faith-based organisations. The Flood Risk Reduction Joint Action Team (FRiRJAT) should target being able to positively change the mindsets and attitude of at least 50 per cent of the people within nine months or between one rainy season and the next towards accepting and prioritising flood risk prevention as key to total family and community well-being and as the only sustainable alternative to community resilience.

Community and opinion leaders need to organise regular community-level and owners' association meetings to enlist the participation of

their members in the prompt dissemination of flood warning from metrological stations and DRR organisations. The roles and responsibilities of individuals, households and groups before, during and after any flood event should be clearly spelt-out and routinely emphasised at community meetings. Vulnerable groups from disaster-prone areas (women and minority groups) should be recognised and empowered to help monitor changes in weather and water levels in the community.

The state and local governments should promote the establishment and empowerment of community-based flood risk reduction guards to enforce residents' compliance to risk reduction regulations such as physical planning standards and building regulations, and also promote the practice of risk reduction and prevention measures including responsible solid waste management practices within their communities.

Rainwater harvesting needs also to be promoted as an affordable and effective flood risk reduction measure in individual homes and public buildings such as schools and health facilities. It will help to reduce the volume of rainwater run-off and eventual flood water in various communities.

Although there is a draft NPA for the implementation of DRR by the Federal Government of Nigeria, time could be saved if stakeholders can adopt a working plan of community participation from other nations where they have recorded more success in DRR and adapt it to our own uniqueness. The Ibadan communities of Oyo State need to realise the importance of their commitment to effective participation in flood risk reduction. A re-orientation of the public and all relevant stakeholders including the organised private- and the popular sectors to identify their roles, take responsibility, know who to call and what to do before,

during and after flood disasters should be accorded top-most priority. Extensive and sustained sensitisation and awareness campaigns and the continuing education of the people in various communities are very vital to achieving effective community participation in flood risk reduction in Ibadan.

## References

- ACE Geography (2014): *Causes of Flood*. Retrieved on 09 March 2018 from [www.acegeography.com](http://www.acegeography.com)
- Adejuwon, G. and Aina, W. (2014): Emergency Preparedness and Response to Ibadan Flood Disaster 2011: Implications for Wellbeing. *Mediterranean Journal of Social Sciences* 5 (8): 500-511.
- Adelekan, I. O. (2010): Vulnerability Assessment of an Urban Flood in Nigeria: Abeokuta Flood 2007. *Natural Hazards* 56 (1): 215–31.
- Adewale, P. O., Sangodoyin, A. Y. and Adamowski, J. (2010): Flood Routing in the Ogunpa River in Nigeria Using Hec-Ras. *Journal of Environmental Hydrology* 18, Paper 25. <http://www.hydroweb.com/journal-hydrology-2010-paper-25.html>
- Ajayi, O., Agbola, S. B., Olokesusi, B. F., Wahab, B., Taiwo, O. J., Gbadegesin, M., Taiwo, D. O., Kolawole, O., Muili, A., Adeola, M. A., Olutade, O. G., Shiji, F. and Abiola, N. A. (2012): Flood Management in an Urban Setting: A Case Study of Ibadan Metropolis. *A special publication of the Nigerian Association of Hydrological Sciences*. Pp. 65-81.
- Atoyebi, O. (2013): Oyo, World Bank in \$220m Flood Management Partnership. *The Punch Newspaper*. Thursday, September 26, p. 6.
- Birkmann, J., Cardona, O. D., Carreño, M. L., Barbat, A. H., Pelling, M. and Schneiderbauer, S. (2013): Framing Vulnerability, Risk and Societal Responses: The MOVE framework. *Natural Hazards* 67: 193–211.

- Drishti, I. A. S. (2015): Community Based Disaster Management. Retrieved March 10, 2018, from <http://www.drishtiiias.com/upsc-exam-gs-resources-COMMUNITY-BASED-DISASTER-MANAGEMENT>
- Eludoyin, A. O., Akinbode, O. M. and Archibong, E. O. (2007): Combating Flood Crisis with Geographic Information System (GIS): An Example from Akure, Southwest Nigeria. International Symposium on Rainfall Rate and Radio Wave Propagation (ISRR'07); Rajasri Sen Jaiswal and S. Uma, AIP Conference Proceedings 923; Conference held in Salem, India, 29-30 January, p. 274-274 (AIPC Homepage).
- Emeribeole, A. (2015): Managing Flood Disaster in Nigerian Cities: Issues and Strategies toward Meeting the Challenges in the Modern World: A Case Study of Owerri Metropolis, Imo State, Nigeria. *FIG Working Week 2015*, from the Wisdom of the Ages to the Challenges of the Modern World. Sofia, Bulgaria, 17-21 May 2015.
- Federal Republic of Nigeria (FRN) (2010): *National Disaster Framework*. Retrieved March 9, 2018 from [https://www.preventionweb.net/files/21708\\_nigherianationaldisastermanagementf.pdf](https://www.preventionweb.net/files/21708_nigherianationaldisastermanagementf.pdf)
- Global Network of Civil Society Networks for Disaster Reduction (GNCSN) (2009): “Clouds but Little Rain” – Views from the Frontline: A Local Perspective of Progress towards Implementation of the Hyogo Framework for Action.
- Ikpefan, F. and Okeke, R. (2018): Agency to Lagos, Ogun, Osun, 31 others: Prepare for Floods. *The Nation Newspaper*, Friday, May 11, p. 9.

- International Federation of Red Cross and Red Crescent Societies (IFRC). (2010): Desk Review on Trends in the Promotion of Community-based Disaster Risk Reduction through Legislation. Background paper for the International Strategy for Disaster Reduction Global Assessment Review. Available at <http://www.ifrc.org/Global/Publications/IDRL/resources/Legislation-and-Community-level-DRR.pdf>
- Iyi, E. and Ugwuanyi, B. (2014): Community Participation Approach to Flood Disaster Management: The Case of Enugu East Local Government Area of Enugu State, Nigeria. *International Journal of Engineering Science Invention*. 3 (12): 04-13.
- Jorgelina, H., Gustavo, P., Luz, S. and Velásquez, B. (2011): Local Disaster Risk Reduction in Latin American Urban Areas. *Environment and Urbanization* 23 (2): 401–413.
- Madu, C. and Kuei, C. (2017): *Handbook of Disaster Risk Reduction and Management*. World Scientific Publishing Company.
- Mwango, N. H. (2010): *Community Traditional Knowledge, Perceptions and Response to Flood Risks in Nyando Basin, Western Kenya*. A Thesis submitted in partial fulfilment for the award of the Degree of Master of Public Health in the School of Health Sciences, Kenyatta University.
- Nash, R. (1982): *Wilderness and the American Mind*, 3rd edition. New Haven, CT: Yale University Press.
- National Water Resources Institute (2011): Report of Assessment of the 26th August 2011 Ibadan Flood Disaster, Oyo State, Nigeria. Kaduna: NWRI.

- National Emergency Management Agency (NEMA) (2008a): *Disaster Risk Reduction for Sustainable Development in Nigeria: National Action Plan for Disaster Risk Reduction, 2006-2015*. NEMA Resource Manual Series, April 2008. Abuja: NEMA.
- (2013b): Report on Flood Disasters in Nigeria. Abuja: Government Press.
- Nigerian Environmental Study and Action Team (NEST) (1991): *Nigeria's Threatened Environment: A National Profile*. Ibadan: NEST.
- Nigerian Metrological Agency (NIMET) (2012): *Nigerian Climate Review Bulletin*. Abuja: NIMET.
- Nkwunonwo, U. C., Malcolm, W. and Brian, B. (2015): Flooding and Flood Risk Reduction in Nigeria: Cardinal Gaps. *Journal of Geography and Natural Disaster* 5:136.
- Nkwunonwo, U. C. (2016): A Review of Flooding and Flood Risk Reduction in Nigeria. *Global Journal of Human-Social Science: (B) Geography, Geo-Sciences, Environmental Science & Disaster Management* 16 (2): 1-20.
- Olorunfemi, F. and Adebimpe, R. (2008): Sustainable Disaster Risk Reduction in Nigeria: Lessons for Developing Countries. *African Research Review* 2 (2): 187-217.
- Osayomi, T. and Oladosu, O. S. (2016): "Expect More Floods in 2013": An Analysis of Flood Preparedness in the Flood Prone City of Ibadan, Nigeria. *AJSD*, 6 (2): 215-237.



- Owoeye, J. and Ogundiran, A. (2014): A study on Housing and Environmental Quality of Moniya Community in Ibadan, Nigeria. *Journal of Environment and Earth Science* 4: 51–60.
- Rahman, M. S. (2008): *Indigenous Knowledge on Flood Risk Management in Bangladesh*. Disaster Reduction Hyperbase.
- Robas, R. and Robas, O. (2014): Flood Disaster Risk Reduction and Risk Management of Pasig City. *Research Gate*. Retrieved March 9, 2018 from [https://www.researchgate.net/publication/269166941\\_](https://www.researchgate.net/publication/269166941_)
- Saidul Huq, S. M. (2016): Community Based Disaster Management Strategy in Bangladesh: Present Status, Future Prospects and Challenges. *European Journal of Research in Social Sciences*, 4 (2): 22-35.
- Sayers, P. Y., Galloway, Li, G., Penning-Rowsell, E., Shen, F., Wen, K., Chen, Y. and Le Quesne, T. (2013): *Flood Risk Management: A Strategic Approach*. Paris: UNESCO.
- Sharma, D. (2002): *Coping Strategies and Early Warning Systems of Tribal People in India in the Face of Natural Disasters: Case Studies in Maurbhanj, Orissa and Dungarpur, Rajasthan, India*. New Delhi: International Labour Office.
- Stam, C. J. (2015): An Evaluation to What Extent Flood-prone Communities in the Mekong Delta (Vietnam) Have been Involved in the Decision-making Processes of Flood Risk Related Policies and Projects. Bachelor Thesis, Faculty of Geosciences, Utrecht University. Available at <https://dspace.library.uu.nl/bitstream/handle/1874/316865/Bachelor%20Thesis%20CJ%20Stam%203635767.pdf?sequence=2>

- United Nations Development Programme (UNDP) (2007): A Global Review: UNDP Support to Institutional and Legislative Systems for Disaster Risk Management. UNDP Bureau for Crisis Prevention and Recovery. Available at: [http://www.preventionweb.net/files/113\\_GlobalReview2007.pdf](http://www.preventionweb.net/files/113_GlobalReview2007.pdf)
- United Nations Economic and Social Commission for Asia and the Pacific (UNESCAP) (2011): *Statistical Yearbook for Asia and the Pacific*, 2011. Bangkok, Thailand: UNESCAP.
- United Nations International Strategy for Disaster Reduction (UNISDR) (2002a): *Living with Risk: A Global Review of Disaster Reduction Initiatives*. Preliminary Version. Geneva: UN Inter-Agency Secretariat, ISDR.
- (2005b): *Hyogo Framework for Action 2005-2015: Building the Resilience of Nations and Communities to Disasters*. Available at <http://www.unisdr.org/2005/wcdr/wcdr-index.htm>
- Van Manen, S. M. (2014): Hazard and Risk perception at Turrialba Volcano (Costa Rica); Implications for Disaster Risk Management. *Applied Geography* 50: 63-73.
- Vojinović, Z. (2015): *Flood Risk: The Holistic Perspective: From Integrated to Interactive Planning for Flood Resilience*. IWA Publishing: London.
- Wand, M. Z., Ayuba, I. G. and Asika, B. G. (2015): Needs for Disaster Risks Reduction Education in Nigeria. *Journal of Environmental Science, Toxicology and Food Technology* 9(1): 43-47.
- Wahab, Bolanle (2013a): Disaster Risk Management in Nigerian Human Settlements. In B. Wahab, N. Atebije and I. Yunusa

- (eds.), *Disaster Risk Management in Nigerian Rural and Urban Settlements*. Pp. 1–37. Abuja: Nigerian Institute of Town Planners and Town Planners Registration Council.
- (2015b): Community Consultation and Sensitization in Risk Management. In O. Y. Balogun and K. A. Aderogba (eds.), *Environment, Risks and Management*. Pp. 107-150. Ijebu-Ode, Nigeria: Department of Geography and Environmental Management.
- Wahab, Bolanle and Falola, Olusegun (2017): The Consequences and Policy Implications of Urban Encroachment into Flood-risk Areas: The Case of Ibadan. *Environmental Hazards*, 16 (1): 1-20, <http://dx.doi.org/10.1080/17477891.2016.1211505>
- World Bank (2014): *Nigeria - Ibadan Urban Flood Management Project* (). Report No: PAD678. Washington, DC: World Bank Group. Accessed on 20/6/2018 at: <http://documents.worldbank.org/curated/en/536881468144274402/Nigeria-Ibadan-Urban-Flood-Management-Project>
- World Meteorological Organization (2008): *Organizing Community Participation for Flood Management – A Tool for Integrated Flood Management*. Version 1.0. Available at [http://www.floodmanagement.info/publications/tools/Tool\\_04\\_Organizing\\_Community\\_Participation\\_for\\_FM.pdf](http://www.floodmanagement.info/publications/tools/Tool_04_Organizing_Community_Participation_for_FM.pdf)

## Chapter 6

### **The Prospects and Challenges of Waste Management Towards Improving Renewable Energy in Nigeria**

Isaac B. Oluwatayo<sup>1</sup> and Ayodeji O. Ojo<sup>2</sup>

<sup>1</sup>University of Limpopo, Sovenga, South Africa

<sup>2</sup>University of Ibadan, Ibadan, Nigeria

Corresponding e-mail: isaac.oluwatayo@ul.ac.za, ayodejiojo7591@gmail.com

#### **6.1 Introduction**

Globally, development is expressed as a function of an uninterrupted power supply (Awosope 2014). This is because of the strong relationship between per capita consumption of electrical power and the level of economic development of any nation. Improving the power situation dominates the infrastructure and development discourse of Nigeria.

This is particularly important to the development of businesses and communities within the country. The nation has allocated huge resources to the power sector without any significant improvement in the last few decades. In fact, Nigeria spent 2.74 trillion naira on the power sector between 1999 and 2015 (Olanipekun 2017). The regulatory framework is elusive as the different models of power generation and transmission over the years have been counterproductive. Nigeria is the most populous black nation in the world with an estimated 180 million people with a 2.6 per cent population growth rate (Worldometer 2018). Nigeria's urbanisation rate

is estimated at 50 per cent (Bloch *et al.* 2015). There is a high level of rural-urban migration in the last few years due to the dearth of opportunities and infrastructure deficits in rural Nigeria. This situation raises the pressure on available infrastructure, security and environment in urban areas.

Wastes are materials that are not prime products (i.e. products produced for the market) for which the generator has no further use for his own purpose of production, transformation or consumption and which he discards or intends or is required to discard (Thomas 2015). Wastes have also been defined as a resource disposed at a wrong location with inappropriate timing in the wrong quantity. Wastes can be converted into compost, energy or raw materials for manufacturing industries. Therefore, it follows that wastes can be recycled for economic advancement and environmental sustainability. This can be carried out by implementing efficient waste management processes and adoption of improved technology. Wastes have been classified based on different criteria in literature (see *Table 6.1*).

## **6.2 Methodology**

The study relied on secondary data from different sources including the World Bank. The need to build a climate resilient economy in a sustainable manner explains the importance attached to clean and renewable energy literature. The increasing fossil fuel consumption resulting in more CO<sub>2</sub> emission has been implicated in adverse climate impacts currently facing our world. Power generation has been inconsistent and inadequate over the years in Nigeria. An estimated 10 per cent of the rural households and 40 per cent of the Nigerian population have access to electricity (Shaaban and Petirin 2014). Therefore, households and businesses rely on generating sets for power generation while the public supply is taken as a back-up. Hence, there

**Table 6.1:** Classification of Wastes

S/n	Basis for classification	Type of waste	Definition/remarks	Examples
1	Physical state	Liquid waste	This includes wastes in liquid form.	Domestic washings, chemicals, oil, wastewater from fisheries and livestock, manufacturing industries and other sources.
		Solid waste	Wastes in solid form	Plastics, Styrofoam containers, bottles, cans, papers, irons etc.
		Gaseous waste	Wastes in gaseous form	Emissions from households' burning fossil fuel for cooking, boilers, manufacturing industries, furnaces, crushers, automobiles, incineration, bush burning, gas flaring and others.
2	Properties	Biodegradable	Wastes that can be broken down by natural processes.	Paper, wood, fruits and others.
		Non-biodegradable	Wastes that cannot decompose naturally.	Plastics, bottles, metals etc.

Climate Change and Socio-ecological Transformation in Nigeria:  
Challenges and Opportunities

**Table 6.1** Continued

S/n	Basis for classification	Type of waste	Definition/remarks	Examples
3	Effect on health and environment	Hazardous	Substances unsafe for commercial, industrial, household consumption. They are typically toxic.	Lead, uranium, heavy metals etc.
		Non-hazardous	Wastes that are not harmful but create disposal issues.	Depleted aerosol cans, non-surgical non-radioactive medical waste, and food waste and by-products of the production process in manufacturing industries.
4	Origin	Household	Typically, food wastes and electronic wastes	Food, electronics, wood etc
		Industrial	Residue of production and electronic wastes-typically in large quantities	Wastes from the production process

**Source:** Thomas, 2015

is a high consumption of fossil fuel because of power generators and equipment with attendant noise and air pollution. In fact, Nigeria spent \$243.6 million on generator imports in 2017 accounting for the second highest expenditure on electronics (WTE 2018).

Waste management can be a source of employment and government revenue or a factor undermining societal healthy living and security

depending on how efficiently it is handled. Globally, there are calls for renewable energy sources in both developed and developing countries. This implies that developing countries including Nigeria need to invest massively in renewable energy sources including solar, wind, bio and agro sources of energy (Efurumibe *et al.* 2014).

Nigeria generates above 32 million tonnes of waste annually out of which less than 30 per cent is collected (Bakare 2016). This implies there is a huge opportunity in the waste management landscape waiting to be harnessed. However, the indiscriminate disposal of household waste in the environment undermines healthy living and household welfare. Generally, wastes have not been properly managed as they block sewage and drainage network. Therefore, the reason urban flooding is high in Nigeria is not far-fetched. About 1.1 million tonnes of waste electrical and electronic equipment (WEEE) was generated in Nigeria in 2010. An estimated 100,000 tonnes of WEEE was imported illegally in 2010 (Uwagbale 2016). Meanwhile, WEEE contains hazardous materials such as lead, mercury, beryllium, cadmium and brominated flame retardants that pose threat to the environment and human health (Uwagbale 2016). The huge waste generated in Nigeria can be harnessed for energy generation and improvement in the livelihoods towards eco-friendly development. Eco-friendly development refers to a significant improvement in the living standards of people as the economy is built on a highly efficient, low-emitting technologies and good management of the environment through appropriate climate resilient frameworks. Renewable energy is the output from clean energy generation from wastes, water and other biological materials such that resources can be replenished over time.

The energy distribution organisation in Nigeria has evolved over the years. Recently, the Nigerian government compartmentalised the power



sector into generation, transmission and distribution companies. The FGN holds 100 per cent stake in the transmission company, 20 per cent in the generation and 40 per cent in the distribution company. The Nigerian Electricity Regulatory Commission (NERC) regulates the activities of all the players in the power sector (Awosope 2014).

### **6.3 Renewable Energy Potentials of Nigeria**

Renewable energy sources are energy supplies that are refilled by natural processes at a rate consistent with consumption. All renewable energy comes, ultimately, from the sun. The sun provides direct energy (as in solar heating systems) or indirect energy (as in hydroelectric power, wind power, and power from biomass fuels). Nigeria is endowed with renewable and non-renewable energy sources. The country is well known for its petroleum, natural gas, tar and coal deposits, and with such vast natural energy resources. Nigeria is also rich in renewable energy sources such as solar, hydro, biomass, and wind energy (Kevelaitis *et al.* 2008).

There are several opportunities in Nigeria for renewable energy. The opportunities abound in every node of the value chain. There are an underserved market and untapped potentials in the energy landscape of Nigeria. Renewable energy potentials are highlighted below:

**Biomass energy:** Biomass energy refers to the energy generated from organic materials including scrap lumber, forest debris, animal wastes (manure) and crops. The biomass resources available in Nigeria include wood, shrubs, forage grasses and wastes from livestock, industrial and municipal areas (Emodi 2016). Nigeria has an estimated  $88 \times 10^2$  megajoule of biomass resources. Currently, fuelwood provides about 80 million  $m^3$  of biomass energy for domestic cooking (Emodi 2016). It is also estimated that shrubs and forage grasses could produce 200

million tonnes of dry biomass capable of producing  $2.28 \times 10^6$  megajoule of energy (Vincent and Yusuf 2014). There is, therefore, the need to conduct more research to understand the sustainability of biomass energy generation in Nigeria. Also, cost requirements and innovative financing options should be profiled to ensure that the governments and investors make informed decisions around renewable energy generation in Nigeria. However, wood, municipal waste, oil palm products, sugar cane and rice husk can be harnessed for renewable energy in Nigeria. The Nigerian sugar mill, paper and packaging companies could convert cane residues and wastes to generate energy as practised in South Africa and Malaysia (Shaaban and Petinrin 2014). The estimated quantities of biomass resources and energy potentials are presented in *Chart 6.1*.

**Chart 6.1:** Biomass Resources

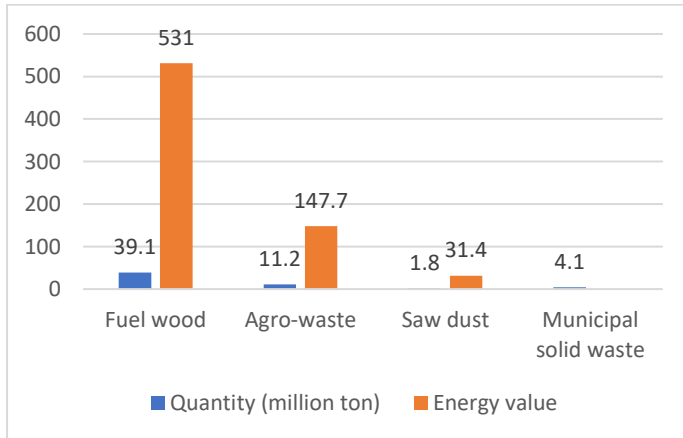

**Source:** Authors' representation of the underlying data from Sambo, 2009

**Biogas:** This is the energy produced from the anaerobic digestion of agricultural, industrial and household waste in the absence of air. Biogas has an estimated combustion temperature in the range of 65-750°C while it is 20 per cent lighter than air. The constituents of biogas are hydrogen sulphide, methane, nitrogen and water vapour (Opeh and Okezie 2011). These can be harnessed for the energy needs of industries and rural households. Biogas is eco-friendly as it reduces GHGs emissions. In Nigeria, biogas is economically viable because of the abundance of the feedstock (raw materials in the biogas generation process) including cassava leaves, dung, solid waste, water hyacinth, water lettuce, agricultural residues, urban refuse and sewage (Akinbami *et al.* 1996 cited in Emodi 2016). According to literature, Nigeria produces about 227,500 tonnes of fresh animal waste daily and 20 kg of municipal solid waste per capita every year (Oyedepo 2012). An estimated 0.03 m<sup>3</sup> of gas can be produced from 1 kg of fresh animal waste translating to a potential 6.8 million m<sup>3</sup> of biogas produced per day. The cooking requirements of a 9-member household can be met by a 6.0m<sup>3</sup> family sized digester producing 2.7 m<sup>3</sup> of biogas per day (Adeoti 1996; Emodi 2016). This implies immense opportunities in waste management towards generating eco-friendly power in Nigeria.

#### **6.4 Challenges of Waste Management for Renewable Energy Generation in Nigeria**

**Knowledge gaps:** There are huge knowledge gaps with regards to the disposal of wastes in Nigeria. Wastes are indiscriminately disposed into water bodies and open field by households, hospitals and industries (see *Figure 6.1*). This constitutes a public health issue and an environmental challenge. This is because it exposes households to airborne and water-borne diseases because of the unsanitary conditions under which they live. Generally, most households require knowledge of the different

kinds of wastes and how they should be disposed of. Also, little is known about available options for renewable energy from waste management in Nigeria.

**Figure 6.1:** Household Wastes Dumped Around a Food Market in Lagos



**Corruption:** Corruption undermines effective waste management in Nigeria. There are regulatory agencies handling waste management in all the tiers of the government. In some states, the government handles waste evacuation and management, which are characterised by inefficiency and corruption. The corrupt practices materialise through delays in the evacuation of wastes and bribery among others. Sanitary inspectors that are meant to enforce environmental hygiene are often compromised and inadequate.

**Infrastructure deficits:** The critical infrastructure for effective waste management including loaders, trucks and waste bins are inadequate. Therefore, most urban centres are underserved by waste management agencies. Again, the required types of mercenary for generating renewable energy are limited in supply. This explains why wastes remain untapped for energy generation and wealth creation.

**Poor planning:** There is a clear disconnection between the opportunities inherent in waste management (with regards to generation, transmission) and distribution of renewable energy owing to poor planning and renewable energy generation in Nigeria (Abila and Kantola 2013). There are no clear energy efficiency standards stating energy efficiency targets. Again, air emission regulation, climate change policy and national building standards are elusive (Edomah 2016). There is the need to incorporate prevailing realities into the existing policy framework.

**The duality of government roles:** The government currently regulates the activities of the players in the waste management and energy landscape. The government also participates as a player in the market providing the services it currently regulates. This compromises efficiency and innovations and undermines level playing field for all actors in the value chain. The government is meant to regulate the activities of service providers in waste management and energy generation. A full participation of the private sector will result in several innovative ways of harnessing wastes for renewable energy.

## **6.5 Conclusion**

Waste management remains critical to economic development and renewable energy in Nigeria. The challenges of waste management have been explained in the paper. The challenges include infrastructure

deficits, knowledge gaps, poor planning, the duplication of government roles and corruption. Nigeria has huge potentials waiting to be tapped in integrated waste management sub-sector. Waste management can be positioned for renewable energy generation to reduce carbon prints and build climate resilient economies. The leveraging on the potentials will also assist in taking development to the doorsteps of the vulnerable within the society.

Based on the findings of the study, the following are recommended: increased awareness creation by the National Orientation Agency (NOA) and other relevant media organisations on appropriate waste disposal methods and the need for the Nigerian households and industries to prioritise environmental hygiene is required; public-private partnerships should be encouraged towards efficient waste management and renewable energy generation; government and multilateral organisations should fund research and development on efficient waste management and renewable energy generation; and government should deprioritise sole management of activities that the private sector can handle more efficiently including waste management.

## References

- Abila, B. and Kantola, J. (2013): Municipal Solid Waste Management Problems in Nigeria: Evolving Knowledge Management Solution. *Journal of World Academy of Science, Engineering and Technology*, 7 (6): 303-308.
- Adeoti, O. (1998): Engineering Economy Studies of Biogas as a Renewable Energy Source at Household Level in Nigeria. Unpublished MSc thesis in Technology Management, Technology Planning and Development Unit, Faculty of Technology, Obafemi Awolowo University, Ile-Ife, Pp1-20.
- Akinbami, J. F., Akinwumi, I. and Salami, A. (1996): National Resources Forum. *UN Sustainable Development Journal*, 20(4):319–332.
- Akinbami, J. F., Ilori, M. O., Oyebisi, T. O., Akinwumi, I. O., Adeoti, O. (2001): Biogas Energy Use in Nigeria: Status, Future Prospects and Policy Implications. *Renewable Sustainable Energy Reviews*, 5(1): 97–112.
- Awosope, C. A. (2014): Nigeria Electricity Industry: Issues, Challenges and Solutions. Covenant University Public Lecture Series, 3 (2), October 2014, Pp. 1-40.
- Bakare, W. (2016): Solid Waste Management in Nigeria. Retrieved from [www.bionergyconsult.com/solid-waste-nigeria/](http://www.bionergyconsult.com/solid-waste-nigeria/) on March 2, 2018.
- Bloch, R., Monroy, J., Fox, S. and Ojo, A. (2015): Urbanisation and Urban Expansion in Nigeria. Urbanisation Research Nigeria (URN) Research Report, ICF International, London, Pp. 1-60.

- Edomah, H. (2016): On the Path to Sustainability: Key Issues on Nigeria's Sustainable Energy Development. *Energy Reports*. 2(2016): 28-34.
- Efurumibe, E. L., Asiegbu, A. D. and Onuu, M. U. (2014): Renewable Energy and Prospects in Nigeria. *Scholarly Journal of Scientific Research and Essay*. 3 (6): 73-76.
- Emodi, N. V. (2016): Energy Policies for Sustainable Development Strategies. *Frontiers in African Business Research*, Pp. 1-60.
- Kevelaitis, K. and Museckaite, R., Obialo, G. R. and Raudonis, V. (2008): Solar Energy Implementation in Nigeria. *Bachelor level in Business Studies, House 44.2, Roskilde University, Fall 2008, Pp. 1-56. <https://core.ac.uk/download/pdf/12517196.pdf>*
- Olanipekun, W. (2017): Breaking the Jinx: The Cyclical Nature of Nigeria's Problems. 22<sup>nd</sup> Convocation Lecture of Ekiti State University Delivered on March 30, 2017, p. 38.
- Opeh, R. and Okezie, U. (2011): The Significance of Biogas Plants in Nigeria's Energy Strategy. *Journal of Physical Sciences and Innovation*. 3: 13-16.
- Oyedepo, S. O. (2012): Energy and Sustainable Development in Nigeria: The way Forward. *Renewable and Sustainable Energy Reviews*, 16 (2012): 2583– 2598.
- Sambo, A. S. (2010): *Renewable Energy Development in Nigeria*. A paper presented at the World Future Council Strategy Workshop on Renewable Energy, Accra, Ghana, June 21-24, 2010, Pp.1-39.



Climate Change and Socio-ecological Transformation in Nigeria:  
Challenges and Opportunities

- Shaaban, M. and Petinrin, J.O. (2014): Renewable Energy Potentials in Nigeria: Meeting Rural Energy Needs. *Renewable and Sustainable Energy Reviews*. 29(2014):72-84.
- Thomas, J. (2015): Industrial Waste Management. Report prepared for USAID Low Emissions Asian Development (LEAD) Programme, Pp1-49.
- Uwagbale E. D. (2016): Hazardous Waste Management and Challenges in Nigeria. *Public Health International*. 1(1):1-5.
- Worldometer (2018): Nigeria Population. Retrieved from <http://www.worldometers.info/world-population/nigeria-population/> on March 2, 2018
- World Top Export (WTE) (2018): <http://www.worldstopexports.com/nigerias-top-10-imports/> on June 1, 2018.

## Chapter 7

# **An Assessment of Industrial Estates for Socio-ecological Transformation of the Nigerian Economy: Case of Oluyole Industrial Estate in Oyo State, Nigeria**

Funmilola O. Morakinyo<sup>1</sup> and Olawale E. Olayide<sup>2</sup>

<sup>1, 2</sup>Development Practice Programme  
Centre for Sustainable Development  
University of Ibadan, Ibadan, Nigeria.  
Corresponding author: lolamorak@gmail.com

### **7.1 Introduction**

Economic development through industrialisation in Ibadan has been an elusive dream for its consecutive governments despite a lot of efforts and policies made towards realising its development target. To follow the models of industrial parks and eco-industrial parks (EIPs) that have helped other states such as Lagos and other countries grow and achieve development in this regard, Oyo State has tried to develop industrial estates to meet this challenge. However, there has not been a significant gain from these efforts due to a myriad of factors.

The discovery of crude oil in Nigeria, which immediately became the primary export commodity and foreign exchange earner, was to worsen the situation leading to the almost total neglect of industries. Unfortunately, the volatility associated with international oil prices frequently led the country's resource expectations into avoidable difficulties resulting in the resurgence of calls for the diversification of Nigeria's economy in general and revenue base in particular.

Some of the recent government policies enacted in response to the need for industrial development include the National Industrial Integrated Development (NIID 2015), the cluster concept. This institution was supposed to jump start and drive industrial development in Nigeria. However, on-the-spot assessment of these policies has shown that not much success has been achieved (UK Essays 2013). Policy inconsistency and the lack of political will have been identified as two major factors responsible for the slow growth of industrialisation in Nigeria and correspondingly in Ibadan (Iwuagwu 2011).

Policies ranging from import substitution era to the Structural Adjustment programme (SAP) regime were at variance with each other. There is the need for consistency in government policies and sustainability to enable stakeholders to consolidate and be able to take their rightful position in the economy (CBN 1993, 2009). The industrial park model if well implemented was supposed to serve as a means to integrate some of these erratic government policies and take the bulk of the implementation from government into the hands of private investors and developers. The extent of the industrial park application in Nigeria is yet to be fully explored and researched.

The development of industrial parks in Nigeria and more importantly in Ibadan has been that of mixed feelings. As much as industrial parks are supposed to be the arbiter of infrastructural and economic development of a region and/or location, the few non-functional industrial parks in Ibadan have failed to achieve this globally important purpose.

The government's policy notwithstanding, the development of industrial parks can be enhanced by the commitment from private investors and developers. The root cause of the hindered growth in industrial parks in Nigeria is multi-headed and not a single solution can be proffered. From social hurdles that need to be surmounted, to the

infrastructural deficit, to the dearth in the availability of complementary industries; all these need to be investigated as part of the bigger picture in order to begin to move in the right direction (Chete *et al* 2012).

As the world focuses attention on the matters of environmental preservation and conservation, it becomes imperative for any country that wants to compete to follow the trend and align with the objectives of maximising resources and sustaining development, which can be achieved through the establishment of EIPs. The EIPs model with emphasis on industrial ecology (IE) has served as a catalyst for development in many countries of the world with typical examples such as the Jurong Park in Singapore and the Shanghai Chemical Park in China (Lambart 2002).

This study is not aimed at examining the various and varying policies of the government with respect to industrial development over time. It evaluates the state of the industrial parks in Ibadan, which can be used as a case study to advocate for a paradigm shift in our outlook on the development of industrial and EIPs to ensure that resources are maximised, and the country can move further in its quest to achieve the SDGs.

The rest of the study is structured as follows: Section 7.2 provides the methodology adopted for the study. Section 7.3 provides the results and succinct discussion of the findings with an evaluation of the effectiveness of the potential industrial parks in Oluyole, Ibadan in Section 7.4. The subsequent sections made a series of assessments of the Oluyole industrial parks'; practice of the principles in Section 7.5, factors enhancing the practices in Section 7.6 and the environmental preservation and conservation plan in Section 7.7. The study ends in section 7.8 with some conclusions and some recommendations based on the findings.

## 7.2 Methodology

The area of the survey is the Oluyole Industrial Estate (parks) shown in *Figure 7.1* (below) and its environs. Apparently, Ibadan is not as established, in terms of industries, as it should be. Hence, the need to seek information from some industries, which are located around Oluyole. Oluyole Industrial Estate does not have all the industries that fall under the categories to be discussed. An example is the agriculture and agro-allied industry, which has no functional company in Oluyole, hence again, the need to seek information from the closest location to the industrial parks. The Oluyole Industrial Estate is located between latitude 7° 21'N - 7° 22'N and longitude 3° 50' - 3° 52'E. The industrial estate is in the south-western part of the ancient city of Ibadan, Nigeria (7°N, 3°E). The city is the second largest in Africa and the third most populated in Nigeria with an estimated population of about 4 million people ([www.tageo.com/index-e-ni-cities-NG.htm](http://www.tageo.com/index-e-ni-cities-NG.htm)). Oluyole Industrial Estate consists of different industries, which include food and beverage processing, organic chemicals manufacturing, basic steel production, agricultural produce processing and production, auto repair workshops, concrete production, pharmaceuticals, agro-allied chemicals and manufacturing. Effluents from these industries are collected via a network of a well-designed drainage system where they are channelled into adjoining rivers (Osibajo *et al.* 2010).

Apart from the industries in the study area, there are also several residential estates and local communities. The two major rivers, River Ona and River Alaro, that flow through the industrial estate are free-flowing and highly turbid, particularly at the points of effluents' discharge in the industrial zone. River Ona is larger and deeper with a huge volume of water than River Alaro.

7 Assessment of Industrial Estates for Socio-ecological Transformation of the Nigerian Economy: Case of Oluyole Industrial Estate in Oyo State, Nigeria  
**Morakinyo, F. O. and Olayide, O. E.**

**Figure 7.1:** Extract Map of Oluyole Industrial Estate in Ibadan Showing the Study Area.

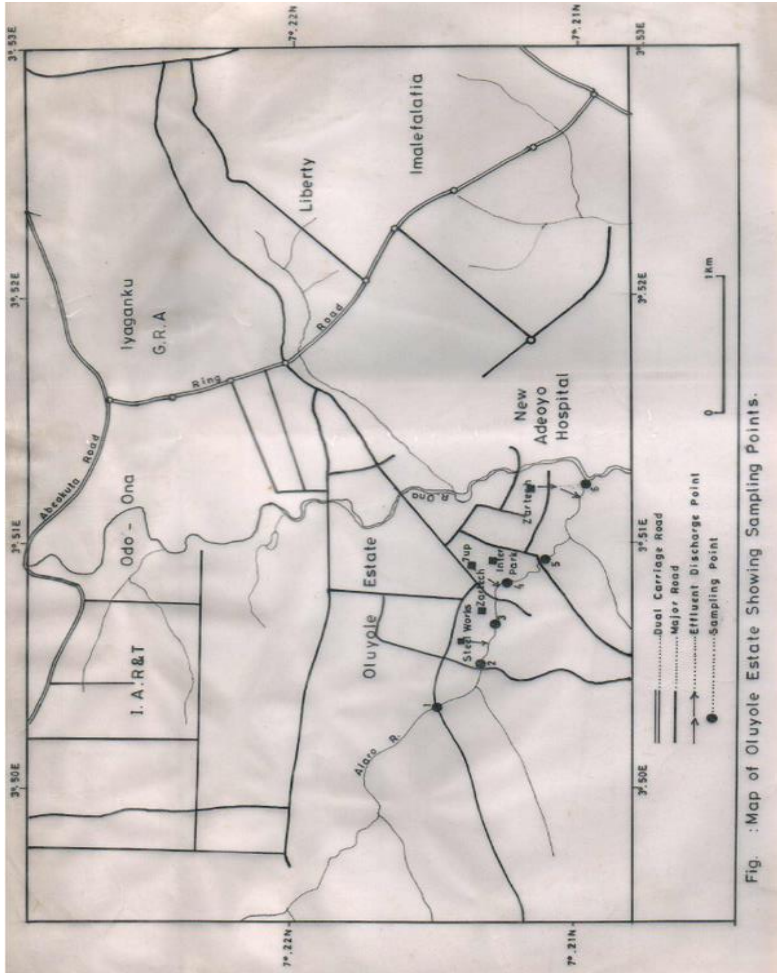

Fig. : Map of Oluyole Estate Showing Sampling Points.

**Source:** Teryila, 2014: Toxic Metal Contamination of Sarotherodon-Melnotheron in Ibadan

The method of analysis adopted in this study is a case study. A representative company was used for each of the industries being analysed. The data generated were analysed using simple descriptive statistics, which are frequencies and percentages. The study is basically a survey research, which is designed to obtain information on assessment for a potential EIPs in Nigeria in Ibadan, Oyo State. It is considered the most appropriate and suitable for this study because it enables the researcher to collect and analyse data on a large population within a short period of time. The data used in this research was gotten through questionnaires.

The data for this study was obtained from eight companies (case studies) located in the study. A detailed survey was conducted (in a form of an interview) with the management of various companies located in Oluyole industrial park. An interview with the workers of such companies with permission from the management was conducted after a prolonged persuasion by the researcher. The needed information was obtained via oral interviews and administering of structured questionnaires. Also, in the aspect of how their waste is disposed of. Questionnaires were distributed to the companies which fall under the industries in the Oluyole Industrial Estate to get the necessary information on how the affairs of such companies are run and the effect of EIPs in the study area on each of the companies.

### **7.3 Results and Discussion**

The survey results describe the productive areas implementing EIPs concepts as well as the areas that need to be addressed to ensure compliance with best practices in industrial parks implementation. The data generated from this research were presented in frequencies distribution tables with simple percentages. The tables comprise data from all the information gathered from the assessment of the state of

the industrial estates in Ibadan. However, the study emphasised and employed descriptive methods, which are based on quantitative analysis.

#### **7.4 Effectiveness of Industrial Parks in Ibadan**

Considering the EIPs concept, which is a concentration of manufacturing and service enterprises installed together in an area where the enterprises involved seek enhanced environmental, economic and social performance through collaboration in managing environmental issues, such as pollution reduction and conservation of water, energy and raw materials. Through cooperation, the enterprises involved seek collective benefit, which is greater than the sum of the individual benefits that each company could achieve by its individual optimisation (Chertow, 2007).

Therefore, the *Chart 7.1* (below), indicates that 37.5 per cent of the industries revealed that their companies pool resources together with other companies and 62.5 per cent of the industries revealed that their companies do not pool resources together with the others. Meanwhile, the result of this research question clearly shows that the level of the effectiveness of industrial parks in Ibadan from the point of companies involved seek individual benefit rather than collective benefit as their degree of collaboration in managing environmental issues were still at the cradle state. This was part of the factors affecting EIPs development in Africa as suggested by Olayide (2015) who opined that, mostly, all the factors affecting the successful implementation of EIPs in Africa can be classed under social governance, economic and environmental issues. Moreover, this individual benefit is nothing compared with the collective benefit which could accrue from a full-fledged practice of 'global model' of industrial parks.



**Chart 7.1:** Distribution of the Companies Pooling Resources Together in the Study Area

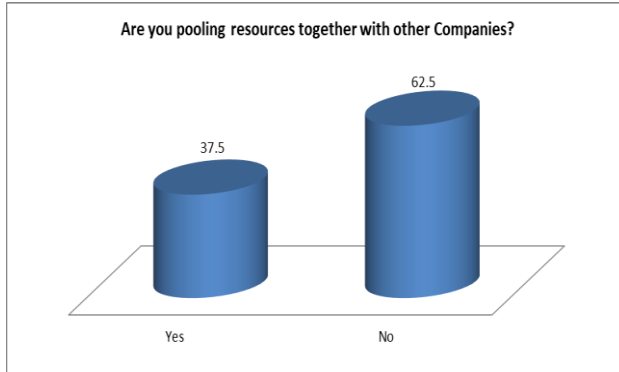

Source: Fieldwork, 2017

### **7.5 Assessment of the Practice of the Principle of Industrial Ecology (IE) and Industrial Symbiosis (IS) at Oluoyole Industrial Parks**

The principle of IE as considered by Graedel (1996), Allenby, (2006) and Kronenberg (2006) was a non-human ‘natural’ ecosystem, as the potential model for industrial activity which places human technological activity (industry) in the larger ecosystems that support it, examining the sources of resources used in society and the sinks that may act to absorb or detoxify wastes. This latter sense of the ‘ecological’ links IE to the questions of carrying capacity and ecological resilience. Chertow (2007) defined the term IS as the sharing of services, utility and by-product resources among industries in order to add value, reduce costs and improve the environment. Industrial Symbiosis (IS) is based on the concepts of IE where the objective is the net production for environmental protection and is a means of implementing the circular economy. Circular economy aims in

minimising the disposal and ‘closing the loop’ of product lifecycles through greater recycling and re-use, eco-design and waste prevention. The *Table 7.1* which analyses the extent at which these parks practice the principle of IE and IS reveals that 75.0per cent of the industries indicate that their company’s waste products serve as input for other companies while 25.0 per cent indicate that the waste products of their companies do not serve as input for others. In this regard, the opinion of the industries as indicated in *Table 7.1* (below) revealed that a good number of industries in these parks practice the principle of IE and IS. It could be said that they only practised one out of the several features of IE and IS, which is ‘resource sharing’. Therefore, the benefits which could be derived from this feature are cost reduction and increased revenues.

**Table 7.1:** Distribution of Companies’ Waste Product Serving as Input for Other Companies

<b>Unit of Analysis</b>	<b>Frequency</b>	<b>Percent</b>
Yes	6	75.0
No	2	25.0
Total	8	100.0

**Source:** Fieldwork, 2017

However, as shown in *Table 7.2*, most of the industries stated that their waste products serve as input for other categories of industry in the parks such as the livestock industry, which takes advantage from waste products emanated from agriculture and agro-allied industry, like faeces of pigs, hens and goats as manure. In the same vein, the livestock

industry also benefited from the waste products that came from the food and beverages industry, such as; waste bread and dough which serve as food for the animals in this industry.

**Table 7.2:** Industries which Benefit from the Principle of Industrial Ecology and Industrial Symbiosis in the Study Area

<b>Industries generating the waste product (raw materials)</b>	<b>Industries which are benefiting from the waste product as input for the production.</b>	<b>Benefited Materials (raw materials)</b>
Food & beverage processing industry	Livestock industry	Waste bread, Waste dough etc.
Packing industry	Agriculture/agro-allied industry	Waste nylon, water rubbers and damaged plastics (recycled and re-used)
Livestock industry	Agriculture/agro-allied industry	Faeces (pigs, hens and goats) which serve as manure
Agriculture/agro-allied industry	<ul style="list-style-type: none"> <li>i. Livestock</li> <li>ii. Packing, and</li> <li>iii. Food &amp; beverage processing industries</li> </ul>	<ul style="list-style-type: none"> <li>i. Livestock; (feeding material)</li> <li>ii. Packaging (carton, tissue paper), and</li> <li>iii. Food &amp; beverage processing (wheat, sorghum, barley)</li> </ul>

**Source:** Fieldwork, 2017

The in-depth interview of one of the staff (name withheld) of the companies under review in the study area, revealed that;

*“Most companies that are situated in the Oluyole Industrial Estate do not pull resources together, they operate individually. There are few things that connect them, majorly road network and industrial symbiosis (the waste product from one company being of use in another). Each company has its own individual power plant, which serves as an alternative to the government power supply.”*

### **7.6 Assessment of the Factors Enhancing the Practice of Industrial Symbiosis (IS) in the Industrial Parks**

A comparison of the practice of IS in the study area was done with the features of IS as stated by Chertow (2007), which are:

- i. Resource sharing;
- ii. Long-term resource security;
- iii. Concentration of recycling enterprises;
- iv. Concentration of enterprises using environmentally friendly technology;
- v. Concentration of enterprises producing environmentally friendly products;
- vi. Mixed-use development (industrial and commercial); and
- vii. Industrial park design on a single environment issue (e.g. a park operated by solar energy) etc.

The *Chart 7.2* reveals that 75.0 per cent of the industries indicate that their operation is powered by the Power Holding Company of Nigeria (PHCN), diesel and petrol generator while 25.0 per cent indicate that their operation is powered by PHCN, diesel and petrol generator and renewable energy such as solar power. In this regard, it was revealed that the industries in the study area power their operation individually,

which was not in conformity with IS. Hence, there is the dire need for the enhancement of IS in the industrial parks in Ibadan. Several ways in which this could be in motion is for the government to first review the existing land use regulation and zoning within the industrial area, which was completely archaic compared to the ‘global model’ of industrial parks.

**Chart 7.2:** Distribution on How the Industries Power Their Operations

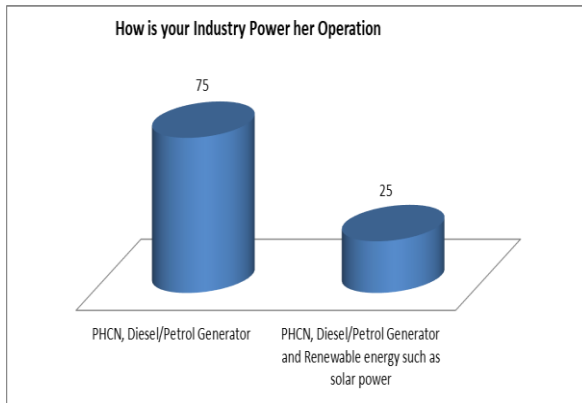

**Source:** Fieldwork, 2017

### **7.7 Assessment of Environmental Preservation and Conservation by Ibadan Industrial Park Plan**

A comprehensive and overall plan, construction and operation of the Oluyole Industrial Park, Ibadan goes thus; a mega estate of parks covering an area of not less than 30–50 square kilometres for large manufacturing companies with high-value addition in the production of finished products. Firms in the same industry would be drawn to the same locations given that proximity generates positive externalities or

‘agglomeration effects’ even as chance events and the government’s inducements will have lasting influences on the geographical patterns of manufacturing. It takes into consideration the resource endowment of Ibadan in terms of labour, land, capital, entrepreneurship, national goodwill etc. (Federal Ministry of Information 1976).

Similarly, the availability of open space was part of the land use regulation and zoning of Oluyole Industrial Park in Ibadan to provide significant environmental quality and health benefits. This was done in order to protect animal and plant habitat, places of natural beauty, and working lands by removing the development pressure and redirecting new growth to existing communities. Additionally, preservation of open space was provided to benefit the environment by combating air pollution, attenuating noise, moderating temperatures, controlling wind and providing erosion control. It would also protect surface and groundwater resources by filtering trash, debris and chemical pollutants before they enter a water system (Federal Ministry of Information 1976).

A model of environmental preservation and conservation on the plan of the Oluyole Industrial Park, Ibadan is to construct a centralised heat supply, air pollution control and environmental monitoring, soil remediation and heavy metal pollution control in the park and application of renewable energy source.

The principles of environmental preservation programme going on in the study area are listed as;

- Refuse, reuse, recycle: do not acquire what you don't need. When you do acquire stuff, make sure they are reusable or at least recyclable.  
Reuse: cloth bags for groceries instead of paper and plastic.

Recycle: donate old furniture, computers, clothes, books instead of trashing them. Use recycled material wherever you can (and products thereof).

- Avoid waste (unnecessary expenditure) of time, energy, money, material, resources. This is a good thing to do in general. Of course, the relative pros and cons need to be considered on a case by case basis. (Example: walking to work is not an excuse to come late to work every day.)
- Encourage businesses that behave responsibly. Discourage those that don't.
- Use common sense: Do not acquire stuff just so that they can later be recycled. Example: recycling plastic water bottles, paper/plastic/thermocool cups are good. Even better is to reuse a bottle or a cup (say, to refill from a water fountain).
- Avoid taking advantage of people and companies that try to make a quick buck in the name of saving the environment. Examples: dubious 'organic' labelled products, organic products sold at an exorbitant price, 'alternative' anything that is sold at a premium that doesn't make sense, etc.

There was another interview of another worker in the industrial estate, name withheld, who stated as follows;

*“In respect to pollution, the government has standing laws, which frown at indecent disposal of waste. All the companies located in the industrial park have ways of treating their waste before being disposed of to reduce the pollution tendency. However, the treatment procedure is still not properly implemented, and once in a while, there is air pollution. Their waste underwent treatment before being disposed of, for those industries whose waste is not industrially ecological.”*

Thus, we see the issue of partial compliance in the implementation of the plan's model. In the light of all these, it is evident that the participants, stakeholders and the governments in the Ibadan industrial park give a minimum attention to its environmental preservation and conservation plan. Also, there is a concrete land use regulation within the industrial area that restricted companies in the industrial park from deciding freely on how to use their land, which could go against the industrial park plan of the study area. *Table 7.3* shows that the entire respondents indicate that there is a land use regulation/guideline within the industrial area.

**Table 7.3:** Existence of Land Use Regulations/guidelines within the Industrial Area

Does a land use regulation exist?	Frequency	Percentage
Yes, there is a land use guideline	8	100.0
No, there is no land use guideline	0	0.0

**Sources:** Fieldwork, 2017

## 7.8 Conclusion and Recommendations

The quest for a rapid industrialisation in order to facilitate economic development has remained the focal point of successive administrations in Nigeria since independence. The study focused on the assessment of the industrial park in Ibadan, Oyo State, Nigeria. This study clearly shows that the level of effectiveness of industrial parks in Ibadan from the point of view of the global concept of a model industrial park is below expectation; the companies' sole aim is to meet the need of their



customers caring little about the infrastructural development of their environs. The companies under study seek individual benefit rather than collective benefit as their degree of collaboration in managing environmental issues was still at its cradle. This finding is not conformity in with the assertion of Chertow (2007) who through his concept of EIPs, demonstrated that through cooperation, the enterprises involved seek collective benefit, which is greater than the sum of the individual benefits that each company could achieve by its individual optimisation. This is further established in the gains as externalities that arise from citing complementary firms around one another. They pool their resources to raise and manage their infrastructure and as well see to managing their environment. Consequently, the IS concept promotes opportunities for community participation in environmental management discussed in Chapter 5 of this book.

In a general sense, achieving an IS concept in Ibadan, when replicated in other parts of the country will contribute to the policy implementation and the development of the all-round economy. This will be by the foremost establishment and sustenance of infrastructure, which dearth is one of the banes of development of Nigeria and Africa (Nwuzor 2015). In respect of IE, the learning opportunities that will accrue from the association of similar and complementary industries will provide an avenue for increased opportunities for research and development, the component of education, which in turn is an aspect of information that will provide for a further education of the participants and society on managing the ecosystem and the climate (Chertow 2007; Nwuzor 2018)

In a narrowed submission, the study shows that industrial park in Ibadan is yet to receive the attention it requires from Nigeria's governments given its critical role as a growth driver and prime mover of economic development. In other words, aside enunciating new economic and

environmental policies, both the state and federal governments must be willing to tread the path of industrial development, which will enable the nation to add value to its primary resources (especially agriculture and minerals). This will further lubricate the industrial process with additional raw materials while enabling the country to earn more foreign exchange. It is therefore imperative to enhance IS in the study area. Several ways in which this could be in motion is for the government to first review the existing land use regulation and zoning within the industrial area, which was obsolete compared with the ‘global model’ of industrial parks and adopt the new model in a quest to achieve the SDGs by the year 2030.

## References

- Allenby, B. (2006): The Ontologies of Industrial Ecology. *Progress in Industrial Ecology, an International Journal*. 3 (1i2): 28–38.
- Central Bank of Nigeria (CBN) (1993a): Perspectives of Economic Policy Reforms in Nigeria. Research Department, CBN, Lagos.
- (2005b): Annual Reports and Statements of Accounts. Abuja.
- Chertow M. R. (2007a): Uncovering Industrial Symbiosis. *Journal of Industrial Ecology*. 11(1): 11–30.
- (2000b): Industrial Symbiosis: Literature and Taxonomy. *Annual Review of Energy and the Environment*. 25 (1): 313–337.
- Chete, L. N., Adeoti, J. O., Adeyinka F. M. and Ogundele O. (2012): Industrial Development and Growth in Nigeria. Learning to Complete. Working Paper 8. Africa Growth Initiative at Brookings, African Development Bank group, United Nations University.
- Dagogo, D. W. (2014): Nigerian Industrial Development between 1943 and 2013: Challenges and Opportunities. *International Review of Research in Emerging Markets and the Global Economy (IRREM)*. An Online International Research Journal.1 (3).
- Federal Ministry of Commerce and Industry (2007): Nigeria's Industrial Development Strategy (2007–2011): The Cluster Concept, Abuja: Federal Ministry of Commerce and Industry.

- Federal Ministry of Information (1976): Second National Development Plan 1970–1974: Programme of Post-war reconstruction and development.
- Graedel, T. E. (1996): On the Concept of Industrial Ecology. *Annual Review of Energy and the Environment*. 21: 69 – 98.
- Iwuagwu, O. (2011): The Cluster Concept: Will Nigeria’s New Industrial Development Strategy Jumpstart the Country’s Industrial Take-off? *Afro Asian Journal of Social Sciences*. 2 (2.4) Quarter IV.
- Kronenberg, J. (2006): Industrial Ecology and Ecological Economics. *Progress in Industrial Ecology, an International Journal*. 3 (1-2): 95–113.
- Lambert, A. J. D. (2002): Eco-industrial Parks: Stimulating Sustainable Development in Mixed Industrial Parks. *Technovation*. 22 (8): 471-484, August 2002.
- Nigerian Industrial Promotion Council (NIPC) (2015): Invest in Nigeria Report.
- Nwuzor, C. V. (2015): *Social Dimensions of Economic Growth and Regional Integration in West Africa*, Chapter 5, Pages 156 – 192. In K. K. Simeon, J. O. Igue and S. O. Akande (Editors) (2015): *Growth and Development in West Africa*.
- Nwuzor, C. V. (2018): *Education in Africa*. Chapter 6, pp. 95–114. In O. Akanle and J. Adesina (Editors) (2018): *The Development of Africa: Issues, Diagnoses and Prognoses*. *Social Indicators*

- Research Series*, 71, 412 pages. Springer International Publishing AG, Switzerland.
- Olayide, E. O. (2015): Industrial Ecology, Industrial Symbiosis and Eco-industrial Parks in Africa: Issues for Sustainable Development. *International Perspectives on Industrial Ecology*. P. 3–36.
- Osibanjo O., Daso, A. P. and Gbadebo, A. M. (2010): The Impact of Industries on Surface Water Quality of River Ona and River Alaro in Oluyole. *African Journal of Biotechnology* 10 (4): 696-702, 24 January 2011 Available online at <http://www.academicjournals.org/AJB>
- Teryila (2014): Toxic metal contamination of Sarotherodon-Melnotheron in Alaro River, Ibadan. *Journal of Food and Nutrition Sciences* · 2014; 2(6): 258-261. Published online November 20, 2014 (<http://www.sciencepublishinggroup.com/j/jfns>)
- UK Essays. November (2013): Review the Industrial Development Policies in Nigeria Economics Essay. Available from: <https://www.ukessays.com/essays/economics/review-the-industrial-development-policies-in-nigeria-economics-essay.php?cref=1>
- UNIDO (1997): *Industrial Parks Principles and Practice*. New York: United Nations Publication. P. 10.
- UNIDO (2012): Conference Report: *Europe and Central Asia Regional Conference on Industrial Parks as a tool to foster local Industrial development*.

*7 Assessment of Industrial Estates for Socio-ecological Transformation of the Nigerian Economy: Case of Oluyole Industrial Estate in Oyo State, Nigeria*  
**Morakinyo, F. O. and Olayide, O. E.**

United Nations (2015): *Global Sustainable Development Report*.

## Notes on Contributors

**Olawale Emmanuel Olayide** is currently a Research Fellow and Sub-Dean at the University of Ibadan Centre for Sustainable Development (CESDEV). Olawale has authored over 40 publications including chapters in *International Perspectives on Industrial Ecology* and *Handbook of Climate Resilience*. He is also the Editor of the *African Journal of Sustainable Development*. Olawale is an Executive Board Member (Director of Communications) of the International Sustainable Development Research Society and the Chairperson of the Thematic Working Group on Africa. He is an expert trainer and an analyst on the Malabo Declaration Reporting Process on Africa Agricultural Transformation Scorecard of the African Union Commission. Olawale is a mentor and consultant in sustainability (social, economic, environmental and governance) issues.

**Idowu O. Kunlere** is an environmental protection expert with Nigeria's top federal environment watchdog, the National Environmental Standards and Regulations Enforcement Agency (NESREA). Much of his recent works, research and community engagements have been in environmental compliance monitoring and inspection, environmental impact assessment, climate action, sustainable waste management, water governance, environmental crimes, eco-entrepreneurship and renewable energy. Idowu, a YALI West African (Regional Leadership Centre) fellow and EXCEED-SWINDON fellow, is the co-founder of Wastesmart Green-Project Foundation (Wastesmart), a community platform for young professionals in sustainability.

**Vincent H. Ogwugwa** is currently a research student at the Department of Microbiology, University of Lagos and has authored three publications. He is an expert in environmental

microbiology with vast experience in bioinformatics, genomics and Polymerase Chain Reaction (PCR) techniques.

**Oluwaseun O. Olubodun**, a doctoral student of the Department of Microbiology, University of Ibadan, is an environmental microbiologist that is passionate about water quality and energy generation. She has over ten years' working experience on water-quality, water and waste-water management in Nigeria. She is a 2016 Mandela Washington Young African Leadership fellow. She is an education enthusiast and is interested in bridging the gap between academic research and its implementation in the industry. She has attended several local and international conferences and presented key papers.

**Alaba S. Kunlere** is currently an educational officer with the Federal Government College, Ikirun, under the Federal Ministry of Education, Abuja. He is also a farmer, trainer, climate justice advocate and researcher. He has conducted various research on the climate change-food security nexus and the response of local farmers in Nigeria to the impacts of climate change. He is also the founder of *School Farm Program*, an initiative which trains unemployed graduates and youths in modern sustainable agricultural practices with strong emphasis on innovative entrepreneurship and sustainability.

**Attia M. El-Tantawi** is currently a vice-dean at the Institute of African Research and Studies, Cairo University. El-Tantawi has authored over 45 publications including two books and editor for two conferences. He is also the editor of the *Journal of African Studies, Cairo University*. He is a professor of climatology. He served as the Head of Department Geography and Deputy Dean, Faculty of applied sciences, UMYU-Katsina, Nigeria 2010-2013. He was a research fellow for one-year, 2017-2018, at the Xinjiang



Institute for Ecology and Geography, Chinese Academy of Sciences (CAS).

**Bao Anming** is currently a director at the Department of Space-to-earth Observation and Simulation, Xinjiang Institute for Ecology and Geography, Chinese Academy of Sciences (CAS). He graduated from the geology department of Xinjiang Institute of Technology in 1988 with a bachelor's degree. In July of the same year, he was assigned to work at Xinjiang Institute of Ecology and Geography under the CAS till now. He is now a research fellow of the Institute and Master's Tutor. In 2001 he was appointed associate research fellow and in 2008 promoted to research fellow, mainly engaged in the research on the resources on the arid zone and environmental remote sensing.

**Murtala Mohammed Ruma** is currently a Faculty Examination Officer at the Faculty of Natural and Applied Science, Umaru Musa Yar'adua University (UMYU), Katsina. He attends more than 25 national and international Conferences. Ruma has authored over 20 publications including two conferences book of proceeding. He is also Article Assessor of the *Journal and Conference Committee*, Isa Kaita College of Education Dutsin-ma. He is a lecturer of water resources and environmental issues. He served as Departmental Examination Officer and Level Coordinator in the Department of Geography, UMYU, Katsina. He is an expert on water quality, quantity, environmental issues and climatology.

**Onyekachukwu Nnaemezie Ugwu** is a graduate of peace and conflict studies at the University of Ibadan's Institute for Peace and Strategic Studies (IPSS). Onyekachukwu has authored several works including working papers presented at both national and international conferences. His master's research investigates the management of the humanitarian needs of IDPs within internally displaced settlements in the Federal Capital Territory (FCT),

Nigeria. Onyekachukwu has contributed to researches and publications with Peace Direct UK and Search for Common Ground (SFCG) on peacebuilding, countering violent extremism, gender and atrocity prevention. He is a member of the Society for Peace Studies and Practice (SPSP), the Institute for Humanitarian Studies and Social Development (IHSD) and the United Network of Young (UNOY) Peacebuilders.

**Bolanle Wahab** is currently a Reader and an Associate Professor at the Department of Urban and Regional Planning, University of Ibadan, Nigeria. He was formerly the Acting Head, Department of Urban and Regional Planning and the pioneer Coordinator of the Indigenous Knowledge and Development (IKAD) Programme at the Centre for Sustainable Development (CSD), University of Ibadan. He is a Fellow of the Nigerian Institute of Town Planners. Bolanle has co-edited 13 books and conference proceedings and also authored and co-authored over 90 journal articles and book chapters including a chapter each in *The Routledge Handbook of Urbanization and Global Environmental Change* and *The Urban Planet*. He has successfully supervised four PhD theses at the University of Ibadan. His research interests include community environmental planning and management, climate change and disaster risk management, integrated waste management and indigenous knowledge systems.

**Ayobola Oluwaseun Faboyede** is an architect and urban planner who loves academia. She is a top-rated content writer in the Upwork Community. She is currently pursuing admission as a PhD research student at the University of Auckland, New Zealand. Her interests lie in disaster reduction, resilience and tourism planning.

**Isaac B. Oluwatayo** is an agricultural and development economist with teaching and research experience in development policy, welfare analysis (poverty and food security issues), gender studies,

social protection issues and financial inclusion. Isaac is a well-travelled person and an awardee of a number of grants and fellowships (academic and research) both locally and internationally. He is a member of the Research Group on Climate Change Adaptation (RGCCA) and an editorial advisory member of the *International Journal of Climate Change Strategies and Management (IJCCSM)*. He has published over 80 articles on several topical issues such as climate change, poverty, food security, vulnerability issues and financial inclusion. His current research interests span through value chain analysis, welfare analysis, economics of climate change, financial inclusion and smallholder agriculture.

**Ayodeji O. Ojo** is a doctoral candidate in the Department of Agricultural Economics at the University of Ibadan. He has over 10 publications to his credit in local and international journals. He presented some of his works in four international conferences on different topical issues in agriculture and development. Ayodeji's research interest is on climate change economics, entrepreneurship and welfare economics.

**Funmilola O. Morakinyo** holds a BTech in computer science and an MSc in sustainable development (development practice) from the Centre for Sustainable Development, the University of Ibadan. She is the CEO of Monan Farm Ventures where she currently practises sustainable agriculture and livestock production. She is a member of the International Society of Sustainability Professionals (ISSP).